



# KOSMOS Review The Detector System

*August 2 & 3, 2010*

- Architecture overview
- Detector characteristics
- Torrent controller status
- Costs and schedules
- Plan for integration prior to delivery

# Architecture overview

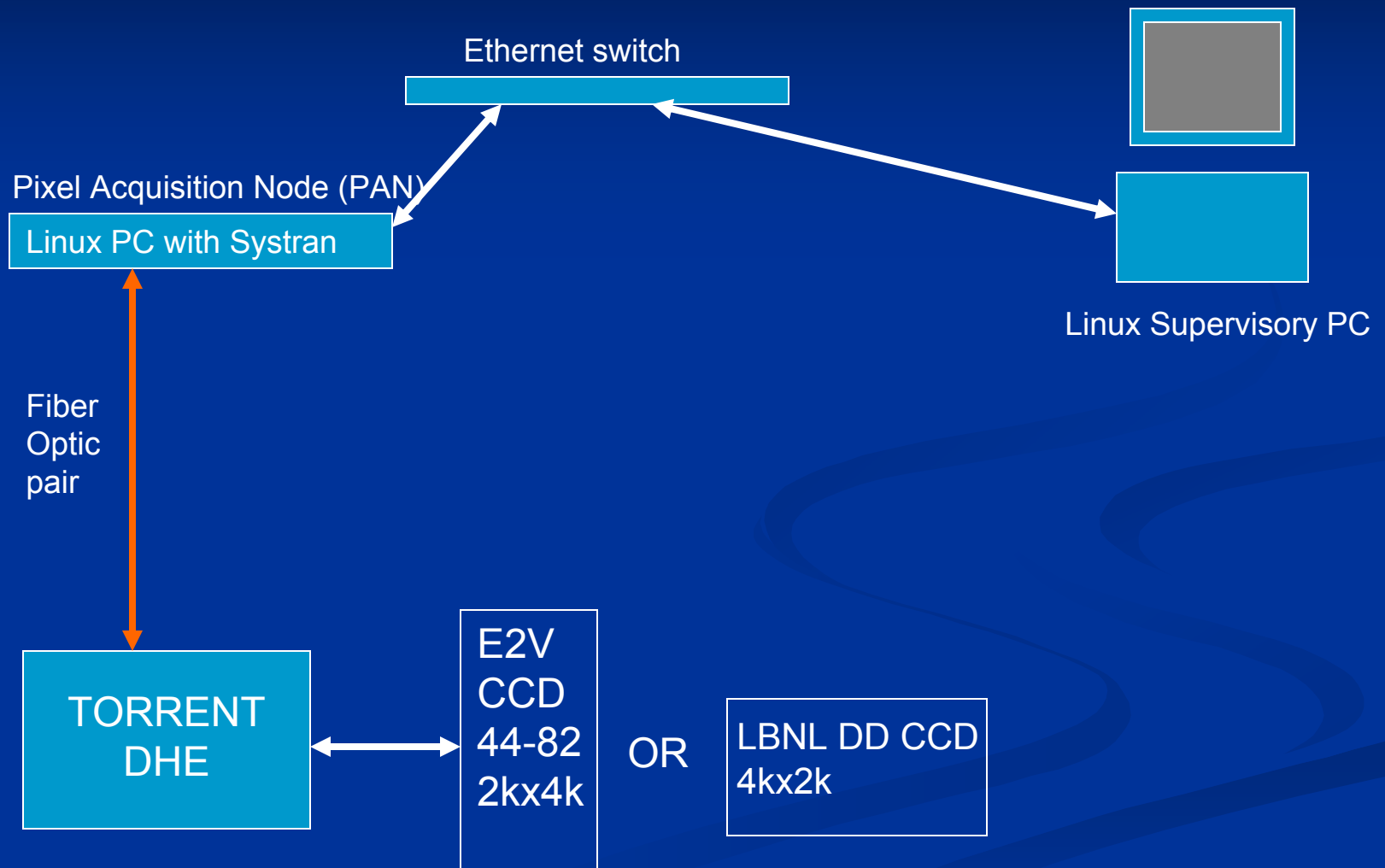

# E2V Detector characteristics

- E2V CCD44-82
  - Better Blue response:  $>50\%$  at 350nm
  - Already in use at NOAO
    - MOSAIC1.1 upgrade
    - Using as a test for Torrent

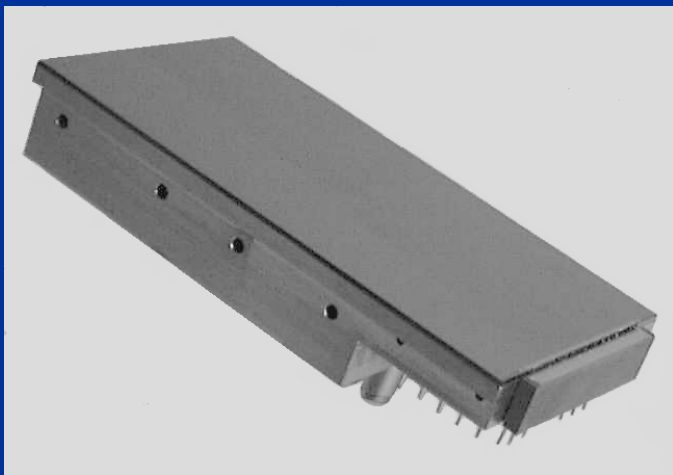

Number of pixels	2048(H) x 4096(V)
Pixel size	15 $\mu\text{m}$ square
Image area	30.7 mm x 61.4 mm
Outputs	2
Package size	31.7 mm x 66.6 mm
Package format	Invar metal package with PGA connector
Focal plane height, above base	14.0 mm
Connectors	PGA
Flatness	20 $\mu\text{m}$ p-v
Amplifier responsivity	6.0 $\mu\text{V}/\text{e}^-$
Readout noise	2.5 e. at 20kHz
Maximum data rate	1 MHz
Image pixel charge storage	200,000 $\text{e}^-$
Dark signal	0.01 $\text{e}^-/\text{pixel}/\text{hour}$ (at 153K)

From E2V Data Sheet

# LBNL Detector characteristics

- 4k x 2k
- 4k along columns for nod & shuffle
- 15  $\mu\text{m}$  pixels
- 4 side buttable package
- Deep depletion
  - Better Red response:  $>60\%$  at 1  $\mu\text{m}$
  - Requires backside bias
- P channel
  - Torrent is able to run with current design
- Ribbon cable exits on rear to connector
- Will require time to integrate & test
  - Also for use in Hydra – S upgrade

The word "TORRENT" is written in a bold, white, sans-serif font with a black outline, slanted upwards to the right. It is set against a dark, starry night sky with a faint horizon line.

# Overview of Torrent

We are presenting a CCD version of the controller, which has:

- 8 channels of video inputs
- 32 clocks
- 16 low voltage biases
- 16 high voltage biases
- Back side bias supply
- Supports either N or P type devices
  - Same controller through configuration files
- Uses the MONSOON software and PAN hardware without modification



# What is Torrent?

- Like MONSOON, Torrent is not an acronym
- It is a smaller more purposed MONSOON
- It is aimed towards:
  - Replacing aging controllers at Kitt Peak & CTIO
  - Use on new instruments that don't need the capabilities of its big brother
  - Helping with commonality of controllers
    - Replace varying controller architectures at both sites



# What is Torrent?

- A *Green* Controller
  - ROHS construction (Lead free solder)
  - Low power consumption
- Mounts to the 'Universal' (N & S) Dewars
  - Different number of connectors N & S
  - Dewar size similar
- Has a small external power supply
  - 24VDC 60W
- Recirculating airflow for cooling





# How big is it?

*Much smaller*  
than Big Brother  
‘Orange’  
MONSOON!

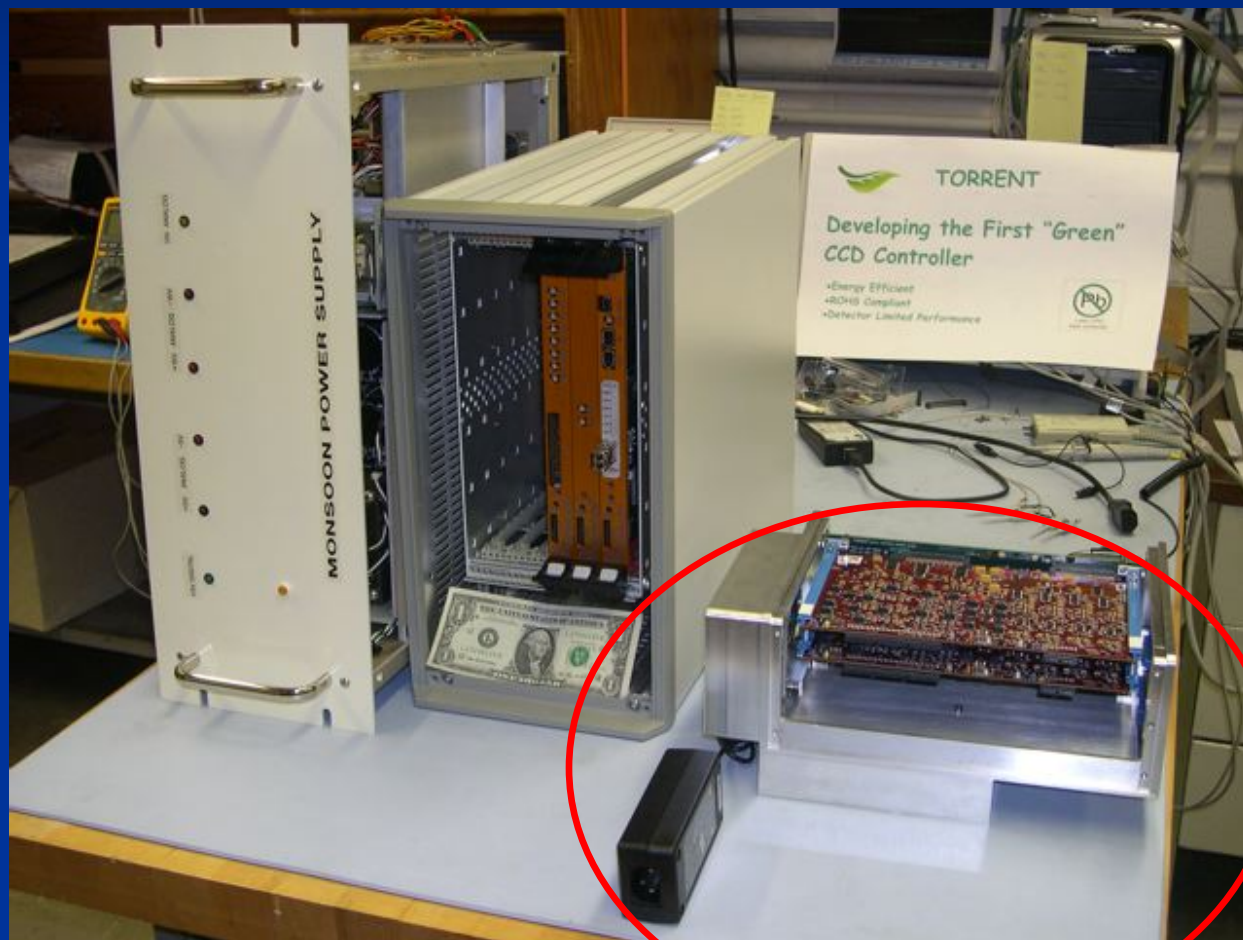

Photo credit: D. Sprayberry

# OK – really, how big?

SAE: 7 5/8" W x 5 7/8" H x 13 1/4" D, 11.8 lbs

Metric: 195mm W x 150mm H x 335mm D, 5.36kg

(Or 19.5cm W x 15cm H x 33.5cm D, 5.36kg)

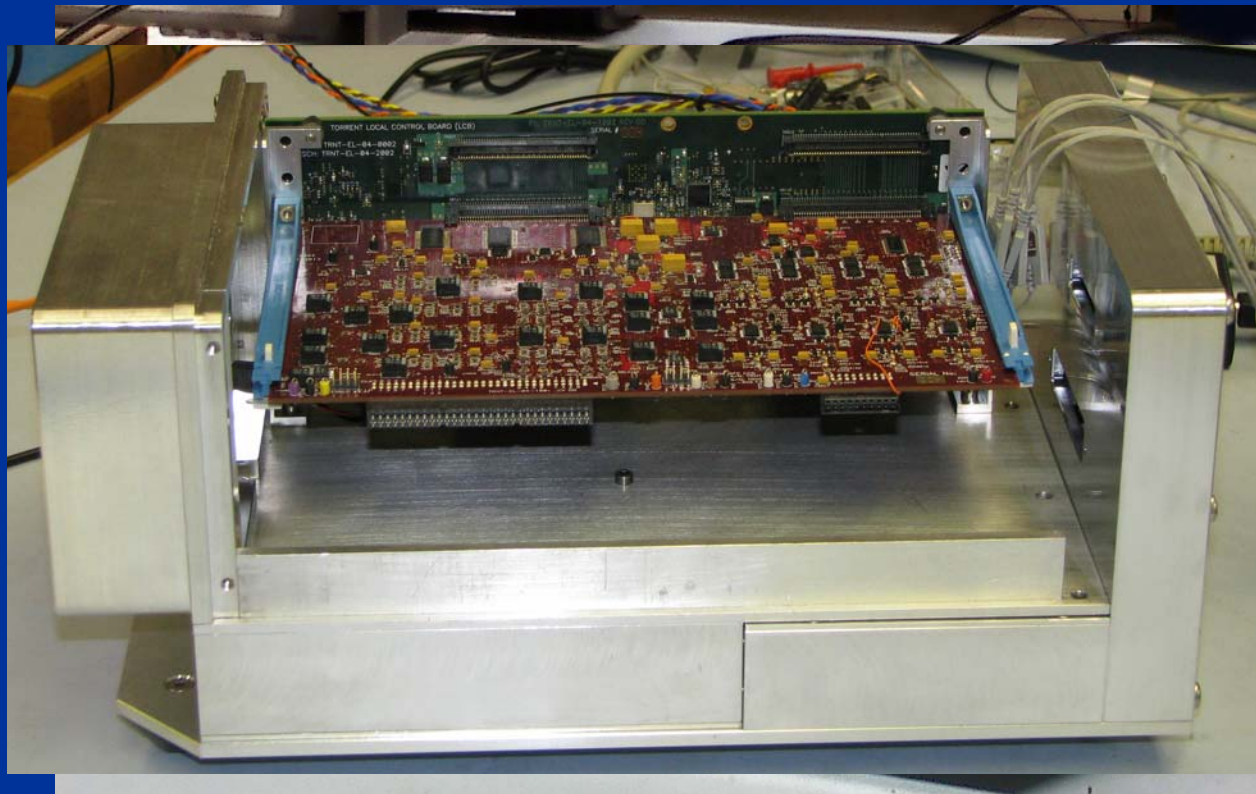

# Torrent Hardware - Names

## Data Head Electronics - DHE

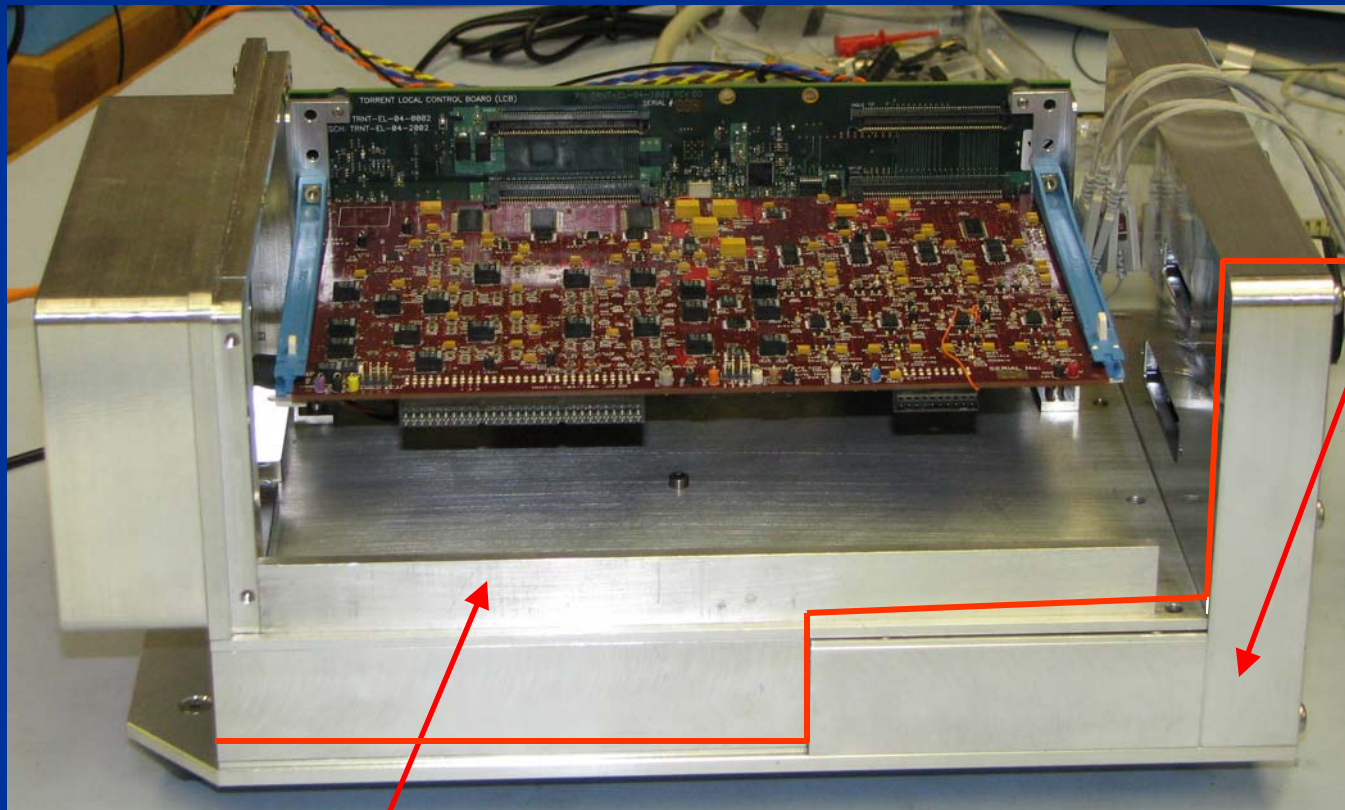

Transition  
Module  
(TSM)

Controller

# Torrent Hardware Parts

Local Control Board (LCB) Mezzanine board (MEZ)

(behind LCB)

Blower

Power  
Supply  
Module  
(PSM)

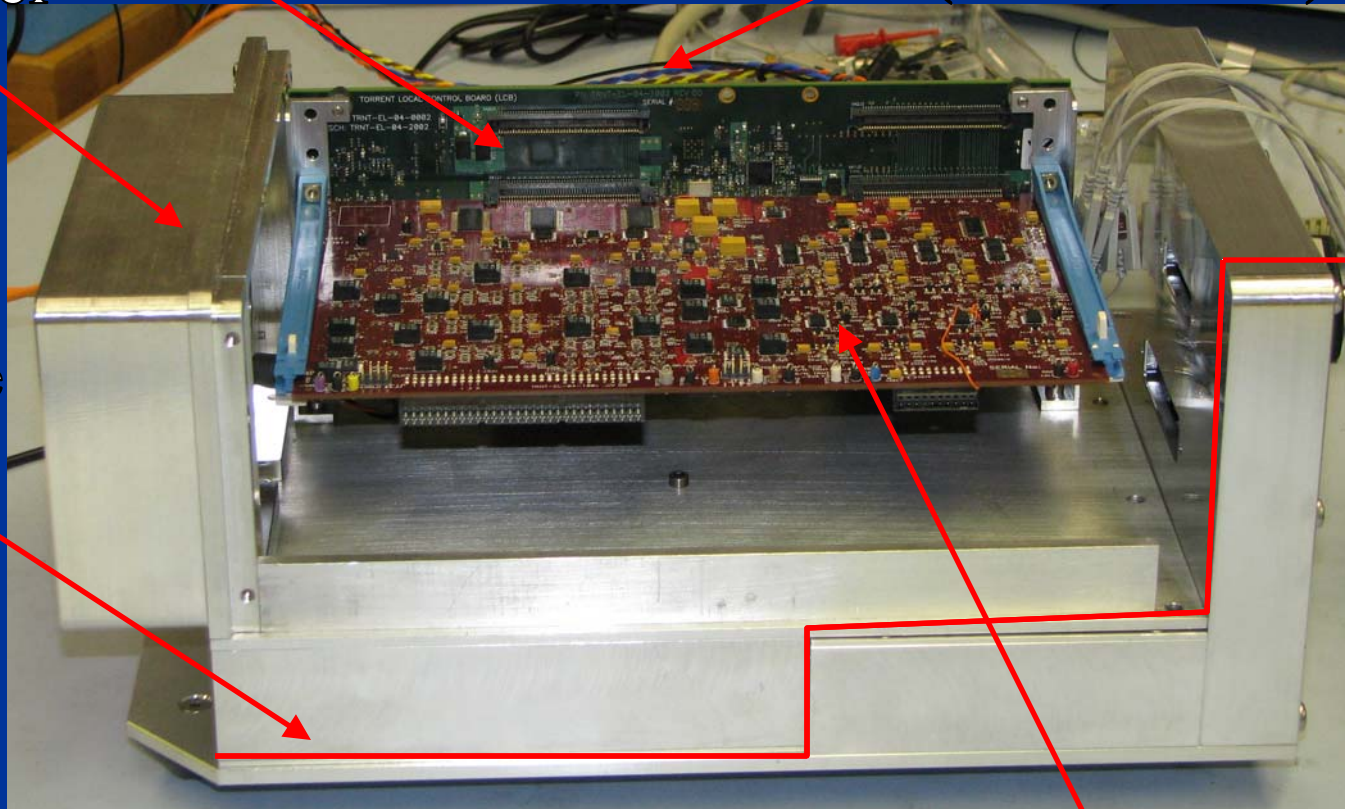

Analog Front End (AFE)

# Other interesting facts

- Power dissipation targeted at  $<30W$
- Integrated closed loop Dewar heater controller
  - Uses either diode or RTD feedback
- Integrated optically isolated shutter output
  - Has two feedback inputs for open/closed feedback
  - Has one other output (preflash?)
- Integrated switching power supply
  - Requires only a small external 24VDC power supply
- Boards are fabricated at outside vendors
  - Allows use of automated assembly for improved yield
  - Allows use of BGA technology and soldered back contacts

# Summary of present progress

- Systems are operational in Tucson and La Serena labs
- Analog Front End (AFE) board is at rev. 1
- Mezzanine board is at rev. 1
- PSM is going to rev. 1 (to include  $V_{BB}$ )
- All other boards at proto level
- Auto-configuration software is in test
- Testing, calibration and EEPROM writing in progress
- Ready to be mounted to an E2V chip in a test dewar in Tucson this week.

# Mechanical Design Summary

- Two complete prototype systems in the lab
    - One in Tucson, one in La Serena
    - Weight is 11.8 lbs or 5.35 kg
  - Mechanical design complete
    - Initial prototype design taken to a complete manufacturing drawing set
      - Includes drawings and assembly details
    - Decision to be made for in house or outside manufacture
      - Inside shop may be overloaded (making KOSMOS?)
      - Cost of outside manufacture unknown at this time – no exotic construction or materials
- (mechanical package just put out to bid 7/29/10)

# Overview of components

Boards and components we will cover:

- Local Control Board (LCB)
- Mezzanine board (MEZ)
- Analog Front End board (AFE)
- Flex Cables (no acronym)
- Transition Module (TSM)
- Power Supply Module (PSM)

LCB

MEZ

AFE

Flex Cables

TSM

PSM

Preamp

Utility



# Local Control Board (LCB)

- Xilinx® Virtex® 5 FPGA - brains of the system
- Controls all parts of the controller
  - No other FPGAs or CPLDs in Torrent
- Multiple communications options
  - Fiber optic, GigE & debug RS232
- Includes code for simulating Systran FO board
  - Acquired from Durham in exchange for updating to Virtex5
- Sync in/out for Master/Slave operation
- EEPROM to hold system data
- Temperature sensors at two locations

# Local Control Board (LCB)

- FPGA code is written using VHDL & Xilinx tools
- Programmed through JTAG programming port
  - Can program FPGA or burn into EEPROM for boot
- Sequencer resides on FPGA
  - Copy of the original 'Orange' code
- TSM Present switch to signal abnormal removal of controller with power on
  - emergency open of output switches and power down
- Watchdog timer in hardware
  - Opens output switches if FPGA stops updating
- 256 Mbytes Buffer memory

# Local Control Board (LCB)

Connections to AFE1 and AFE2

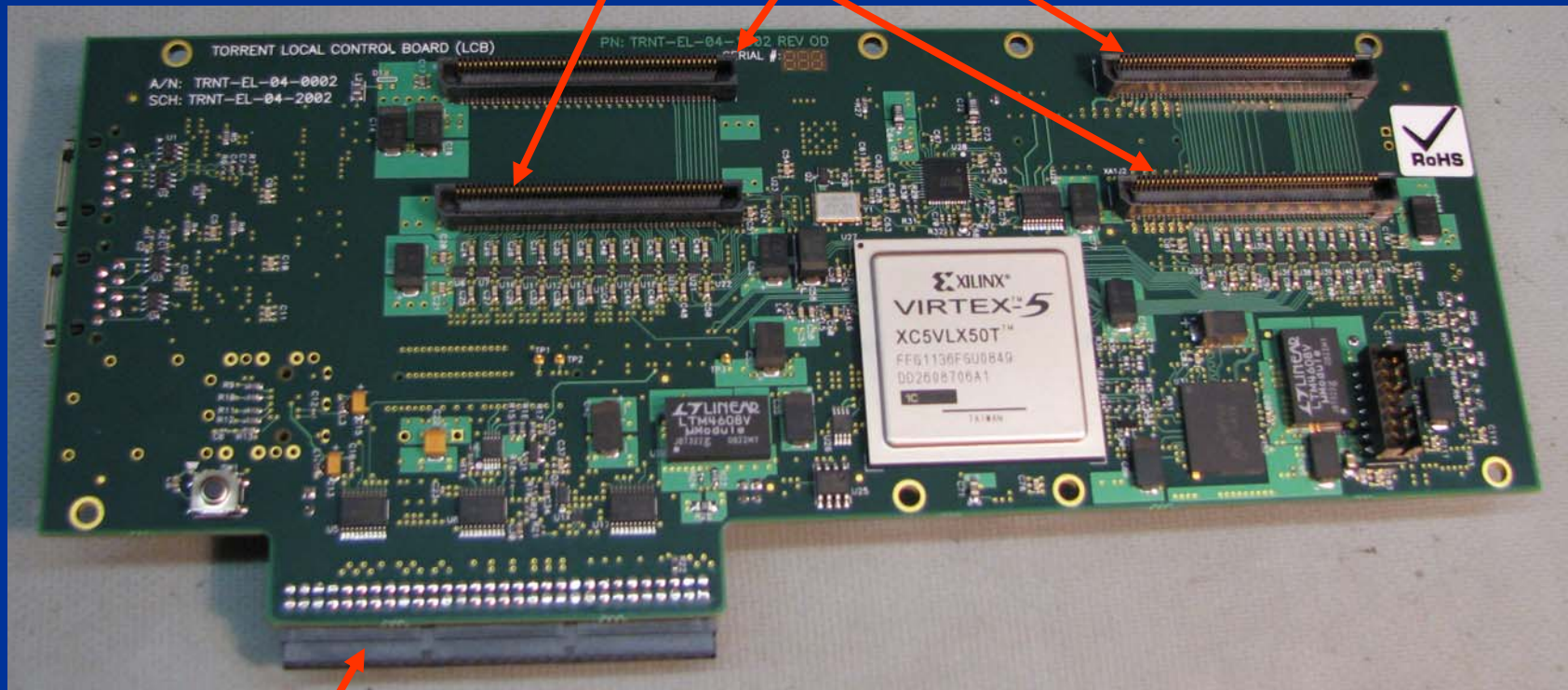

Connection to PSM

# Mezzanine Board (MEZ)

- Controls the power to the two AFE boards
  - Holds power switching circuitry
    - Allows sequencing of different sections
  - Current measurement
  - Shutdown on overcurrent
  - Monitors for fault
  - On mezzanine board due to space constraints
    - (as well as our confidence that it would work first time)

# MEZ

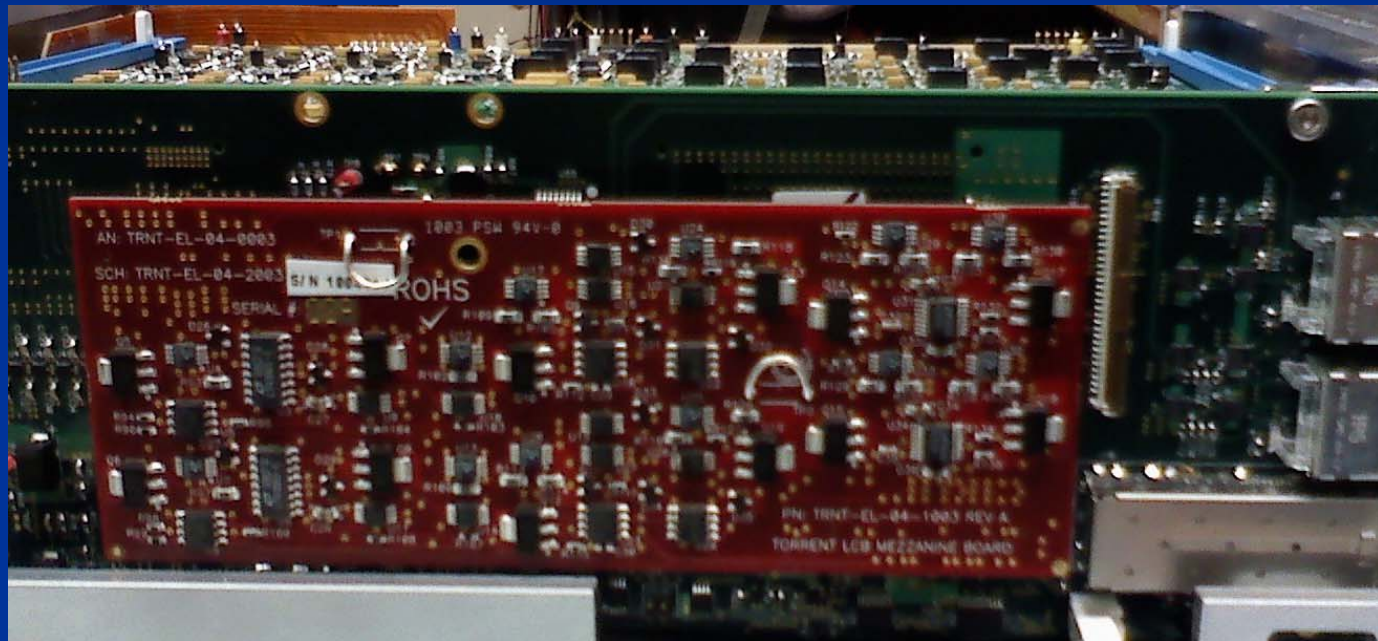

(Sorry about the focus!)

# CCD Analog Front End (AFE)

- 4 channels of CCD input
  - DC restored, dual slope Correlated Double Sampling (CDS) Video
- 8 channels of Low Voltage Biases:  $\pm 17V$
- 16 channels of clocks:  $\pm 17V$
- 8 channels of High Voltage Biases:  
0 to 30V or -30V to 0
- On board regulators and references

# CCD AFE

- EEPROM to hold calibration data
- Temperature sensors at two locations
- Optimized for 100 kpix/sec – 350 kpix/sec
- Programmable test points for system debug
  - Allows viewing of clocks or biases on board edge connectors during code development

# Block Diagram of AFE

- Sections of the AFE
  - Shows the relative location of sections
  - Important for noise control
  - Clocks as far away from Video as possible
  - Allows ground current control
- Lower chance for ground loops with single board for all connections to CCD

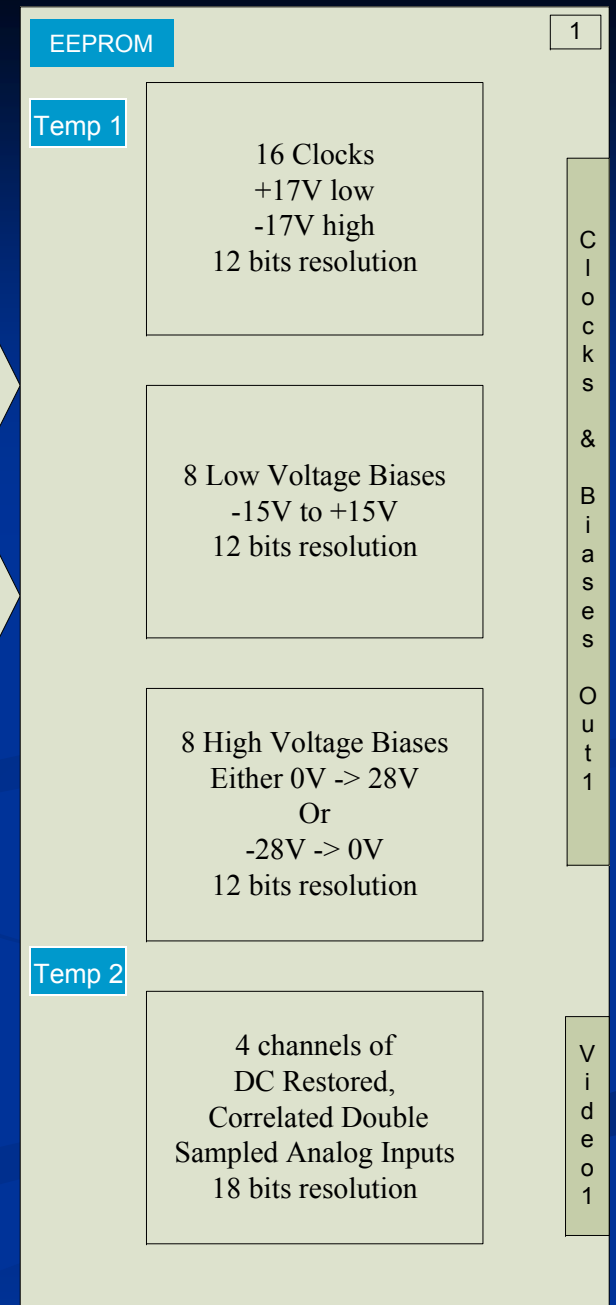
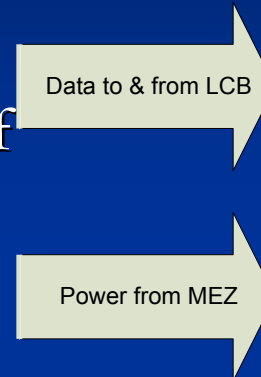



# CCD AFE

- Designs for Torrent very similar to Orange
  - Clocks, Video processing & Bias blocks identical
- Changes:
  - Higher density/Finer resolution DACS
    - 16 buffered DACs in a single package vs. 8
    - 12 bit DACs vs. 8 bit
  - Different switches for clocks and video
    - Clock switches are smaller and lower  $R_{on}$
    - Video switches no longer needs logic supply
  - First video amplifier placed closer to Dewar connectors in TSM

# CCD AFE Testing

- All clocks tested over full range and loads
  - Unloaded rise time of  $<150$  ns
- All LV Biases tested for drive, range and noise
- All HV Biases tested for drive, range, noise for both polarities
- Video channels have five different tests for noise to check each section

# CCD AFE

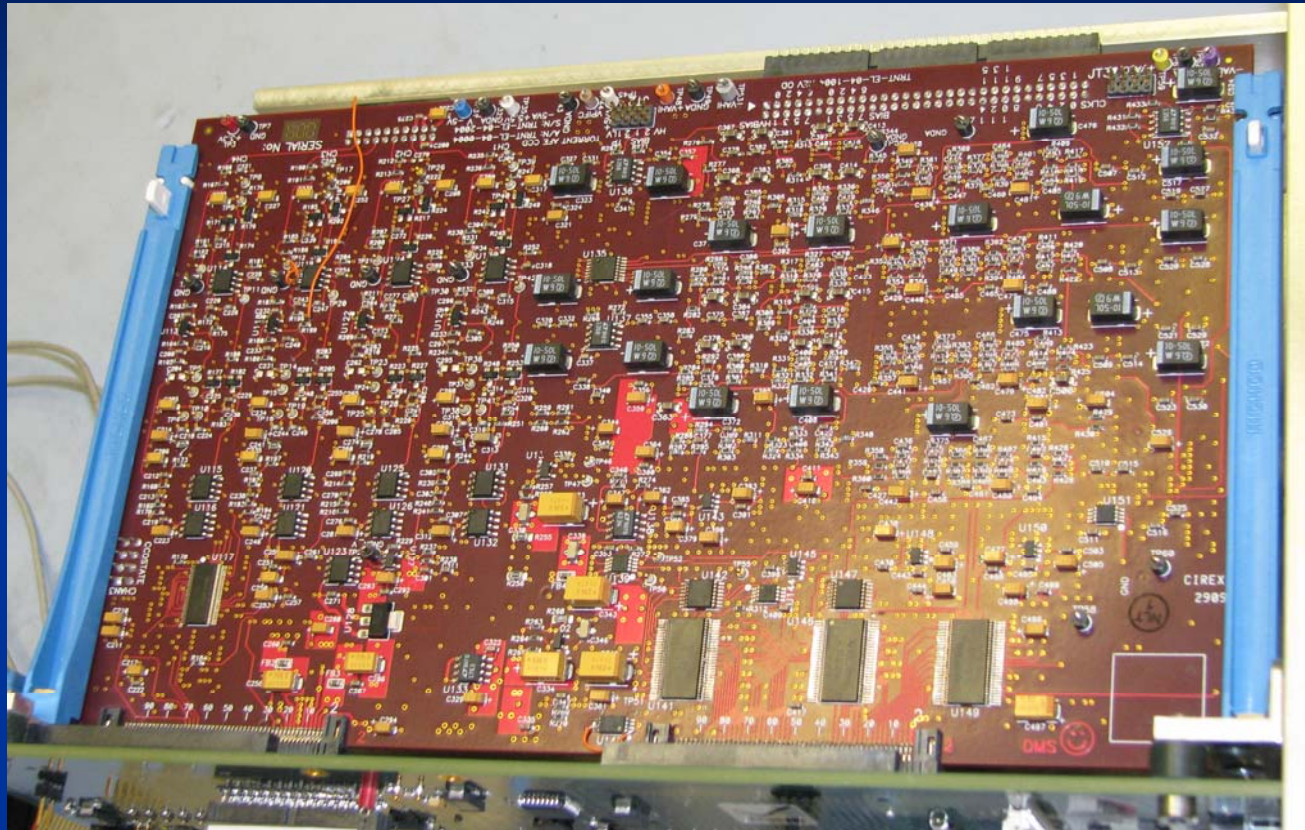

Two boards supplied in each chassis for the total channel count: (8 vid/16 LVB/16 HVB/32 Clk)

# CCD AFE misc

- CCD type done first as opposed to IR
  - More requirements for CCD vs. IR
- We have a reference design for the IR version with 16 channels for each board for a 32 input IR Torrent
- We also have an oversampler design for extremely low noise ( $<1e^-$ ) using statistical oversampling
  - Developed through the Clinic Program with Harvey Mudd Engineering students ( [www.hmc.edu](http://www.hmc.edu) )

# Flex circuits

- We are using flex cables to connect the AFE sections to the TSM
  - One cable carries the Clocks and Biases
  - One cable carries the video inputs
  - Each cable supports two AFE cards
- Selected to help control crosstalk and impedance
  - Controlled by layout of flex cable
  - Assists with airflow

# Flex cables installed

- Shows the Clocks & Biases flex and Video flex

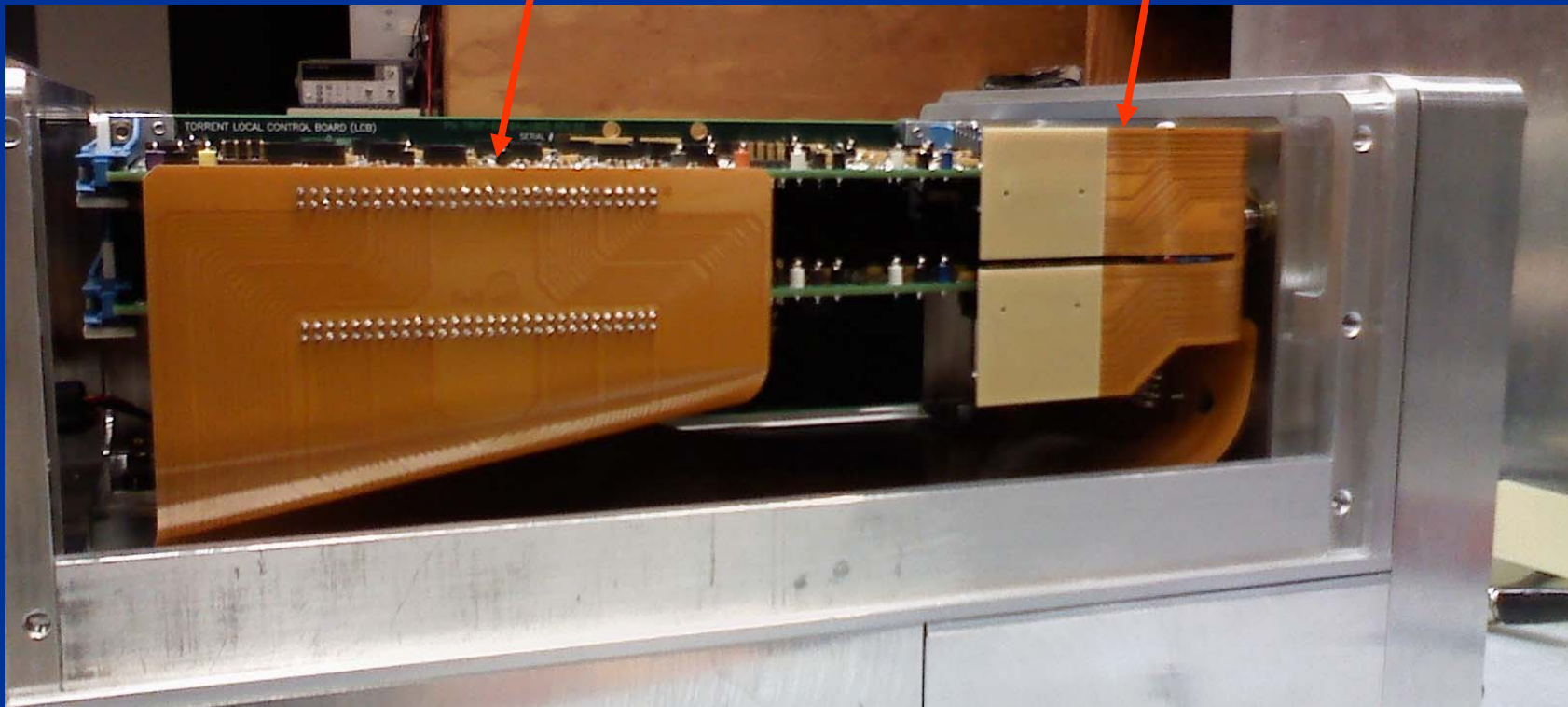

# Connecting Controller to TSM

- Selected D series connectors from Positronics
  - Two High density connectors for AFE signals
  - Standard D25 for Utility Board
  - Connectors have guide pins for alignment
    - One side floats
    - Other side is fixed
- TSM Present switch in controller to detect:
  - If there is a TSM
  - Removal of controller with power on
- Shorting switch in TSM to short CCD Sub to shield when controller removed
  - Time between removal of controller & insertion of shorting plug

# TSM and Controller Connectors



Video – Top

Clock & Bias - Bottom

Utility Connector

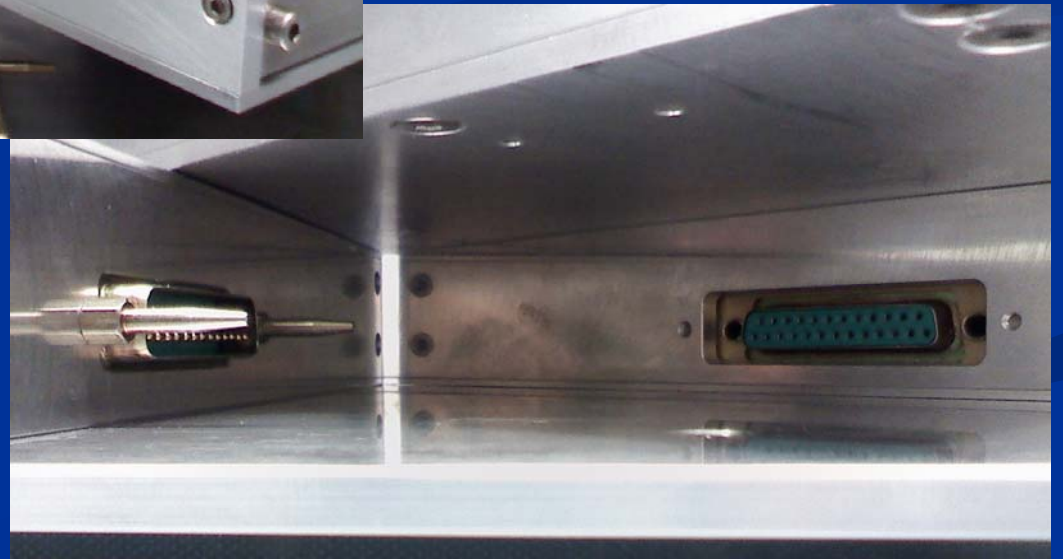



# Transition Module

- Resides on the Dewar
- Interface to the Dewar
- Preamp to buffer the CCD
- Shutter & preflash outputs
- Dewar CCD temperature control
- EEPROM to hold system configuration
- Temperature sensors, as usual

# TSM

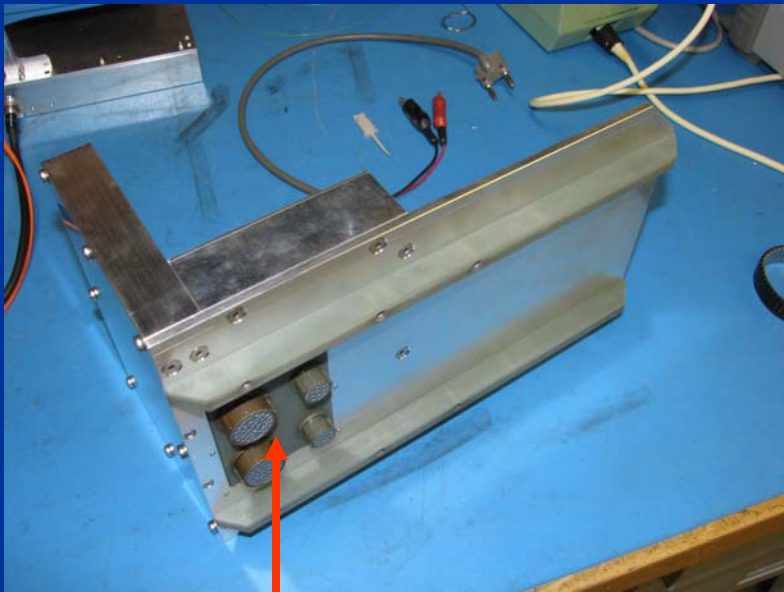

Dewar Connectors

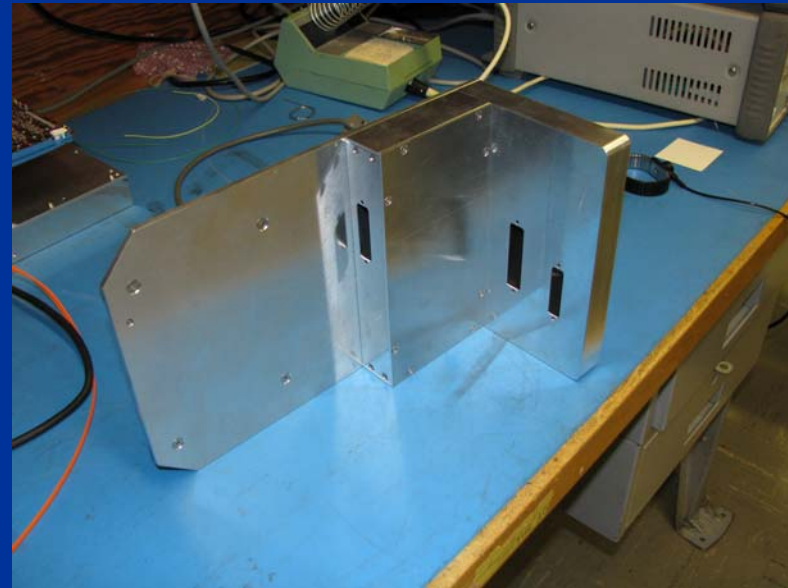

# TSM Preamp

- Same as first stage of Orange design
  - Load resistor for CCD
  - Capacitor for DC removal
  - Initial conditioning of CCD signal
    - 1<sup>st</sup> stage gain
    - Low pass in feedback
- Is the connection area for the Video, Biases and Clocks to Dewar interface
- Allows filtering for Clocks and Biases
  - Simple RC network for customization

# TSM Utility

- Added to handle functions missing on Orange as well as new functions
- EEPROM and two Temperature sensors
  - EEPROM holds configuration data for system
- Opto Isolated Shutter and Preflash outputs
- Two Opto Isolated status inputs
- CCD Thermal control
  - Calibrate for Diode or RTD sensors
  - Heater output up to 8W, jumper selectable

# TSM Utility Board

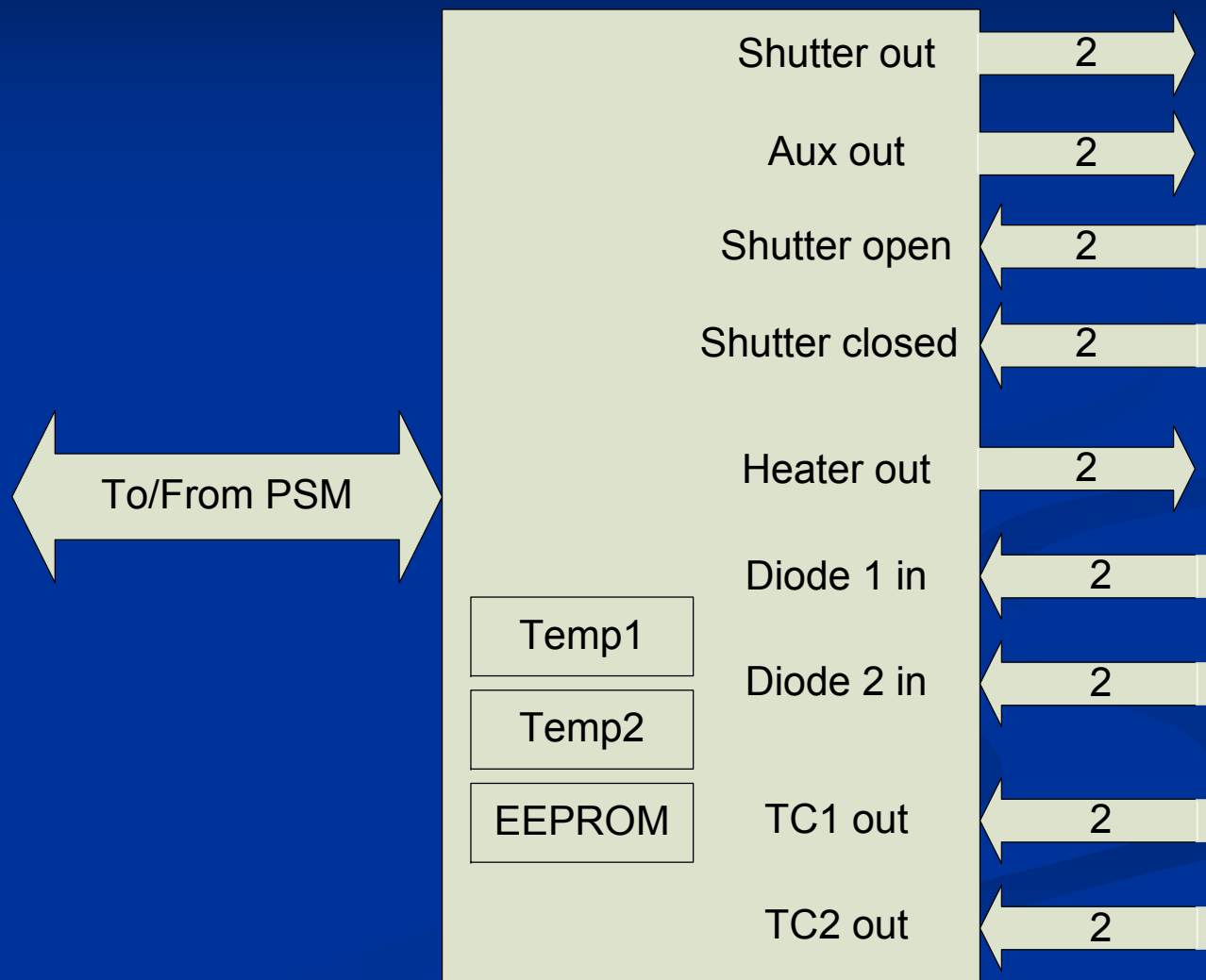

# Connectors on the TSM:

## External:

- Shutter out\*
- Aux out (preflash)\*
- Status 1 in (shutter open)\*
- Status 2 in (shutter closed)\*
  - All on a bulkhead mount Lemo 8 pin circular connector
- TC1 (monitor on CCD) and TC2 (monitor on tank)
  - Bulkhead TC Connectors

\*Note: These are optically isolated:

- Resistor to power & common needed for OC output
- Series resistor & common to drive the LED for input

## Internal:

- Heater out\*\*
- Temp 1 in
- Temp 2 in

\*\*Power level programmed by the heater power selection jumper on Utility board

- Connected back to the LCB through PSM
  - EEPROM
  - Temp1
  - Temp2

# Power Supply Module (PSM)

- External power is 24VDC
  - Inline notebook type medical grade power supply
  - Could use an enclosed type mounted in instrument enclosure
- PSM board resides with controller
  - Has fixed 3.3V logic supplies
  - Has adjustable supplies for  $\pm 15$  to  $\pm 20$ V and  $\pm 5$  to  $\pm 8$ V
  - Has -5/+30V or -30/+5V for HV Biases
    - N or P type devices
  - Has a Backside Bias of up to 70V
    - Polarity is opposite of HV power
  - Mounts in a machined aluminum box (uses conductive cooling)
  - Separate box due to EMI considerations
  - EEPROM to hold calibration data
  - Temperature sensors at two locations

# Power Supply Module (PSM)

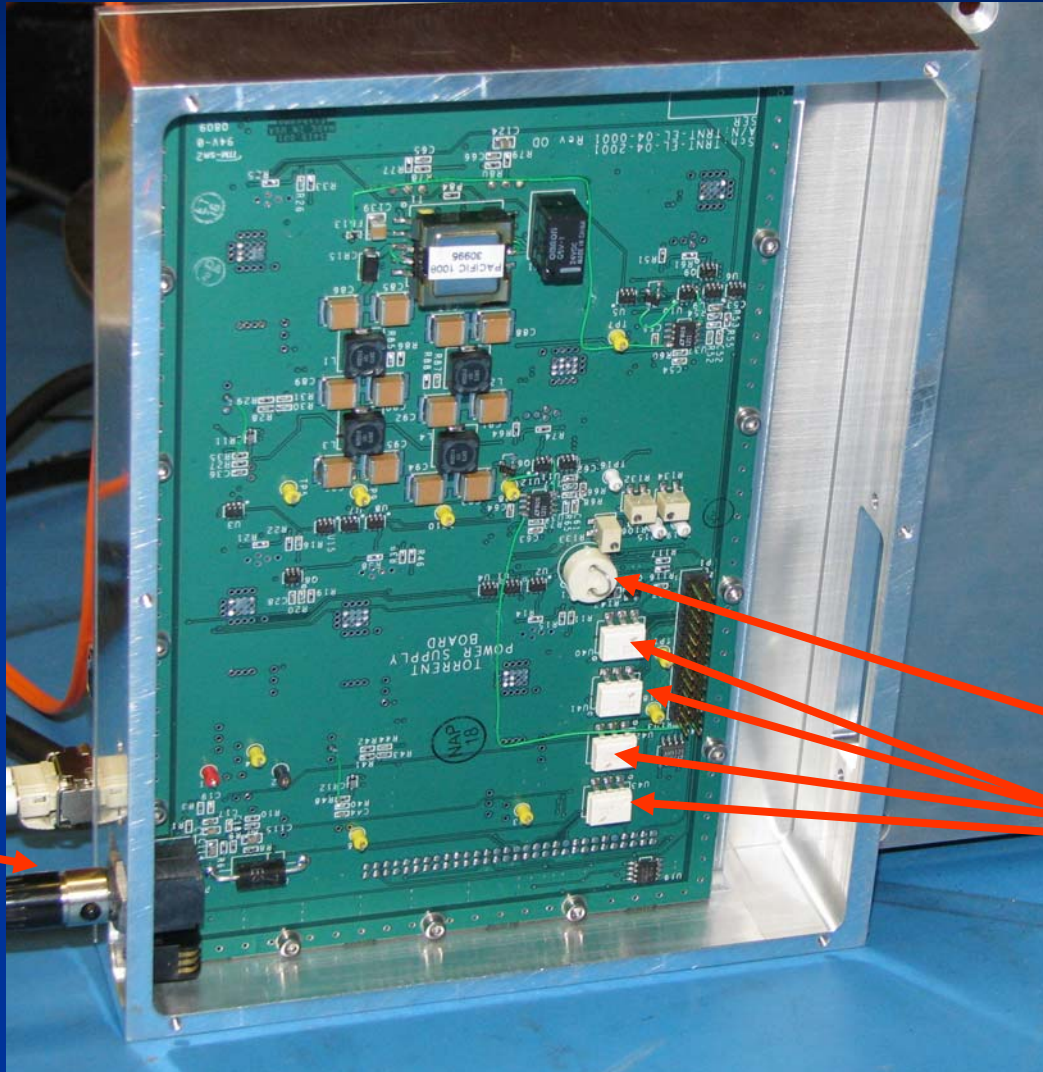

Power In

Fuse for Heater

Opto isolators



# Cost & schedule

- Torrent manufacturing review August 20
- After review items taken care of:
  - Nominal start of Sept 1
  - Start manufacture process for all boards needed
    - Includes getting rest parts needed
  - Start mechanical fabrication
    - We will be making multiple copies (15 – 20)
  - Determine final system cost
    - Should be under \$15k including PAN & Systran
  - Board testing fixturing design & build starts
    - Testing of all boards and sub-assemblies

# Plan for integration prior to delivery

- First mechanical assemblies due Nov '10
- All boards should be ordered or in house by Dec '10
  - Need inspection before power up! Takes 1 – 2 days per board
- Dewar modifications can start before CCD is ordered
- Assembly and test of first production Torrents should start Jan '11
- Integration of dewar, CCD & Torrent starts in Feb '11
- Testing complete by late Feb '11,
- Ready to take a plane flight to Ohio in March '11
  - Includes Dewar with CCD, Torrent, PAN computer with Systran and fibers for link
  - Software already available on the MONSOON website



# The Torrent Team

- The main people :
  - Mark Huntten, Project Manager
  - Nick Buchholz, Senior Software Engineer
  - Phil Daly , Senior Software Engineer
  - Ron George, Engineer
  - Peter Moore, Senior Engineer
  - Roy Olson, Technical Writer
  - Dave Sawyer, Senior Engineer, MOSAIC1.1 Proj. Mgr.
  - Dee Stover, Designer & PCB Layout wizard
- People who have put in many hours:
  - Joe DeVries, mechanical engineer
  - The Technicians:
    - Kathy Zelaya, Jack Carlson, Ken Don