

TOP SIDE CONDUCTORS (LAYER-1) PRIMARY  
POSITIVE IMAGE WHEN BOX IS FILLED ■

National Optical Astronomy Observatory  
Drawing Number: TRNT-EL-04-3003 REV A  
Next Assy: TRNT-EL-04-1003  
TORRENT LCB MEZZANINE BOARD 15DEC09 SH 1 of 10

NOT APPROVED  
FOR CONSTRUCTION  
12-15-09

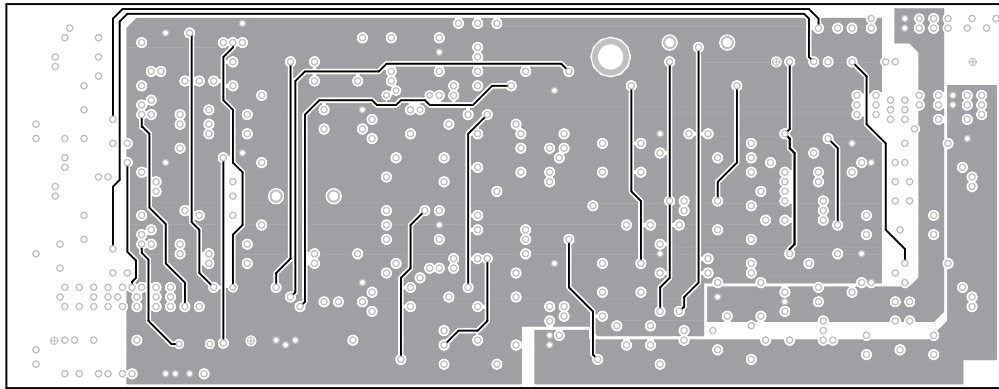

SIGNAL INTERNAL (LAYER-2)  
POSITIVE IMAGE WHEN BOX IS FILLED ■

National Optical Astronomy Observatory  
Drawing Number: TRNT-EL-04-3003 REV A  
Next Assy: TRNT-EL-04-1003  
TORRENT LCB MEZZANINE BOARD 15DEC09 SH 2 of 10

NOT APPROVED  
FOR CONSTRUCTION  
12-15-09

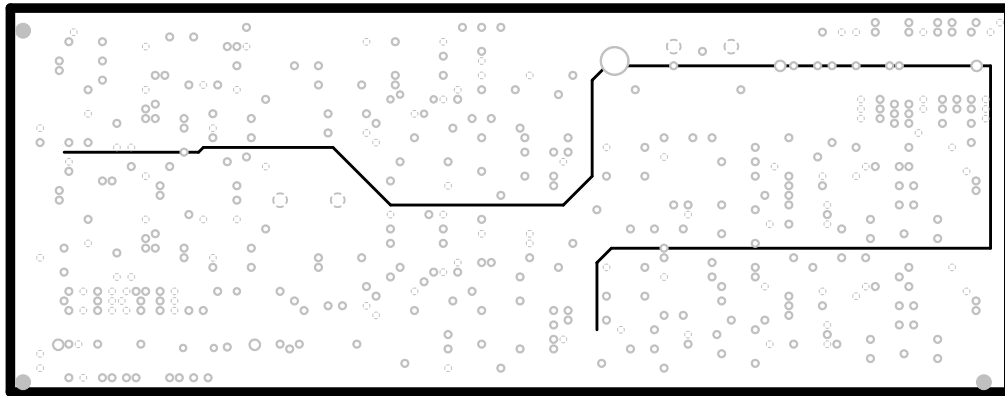

PLANE - GROUND (LAYER-4)

POSITIVE IMAGE WHEN BOX IS FILLED

National Optical Astronomy Observatory

Drawing Number: TRNT-EL-04-3003 REV A

Next Assy: TRNT-EL-04-1003

TORRENT LCB MEZZANINE BOARD

15DEC09 SH 4 of 10

NOT APPROVED  
FOR CONSTRUCTION  
12-15-09

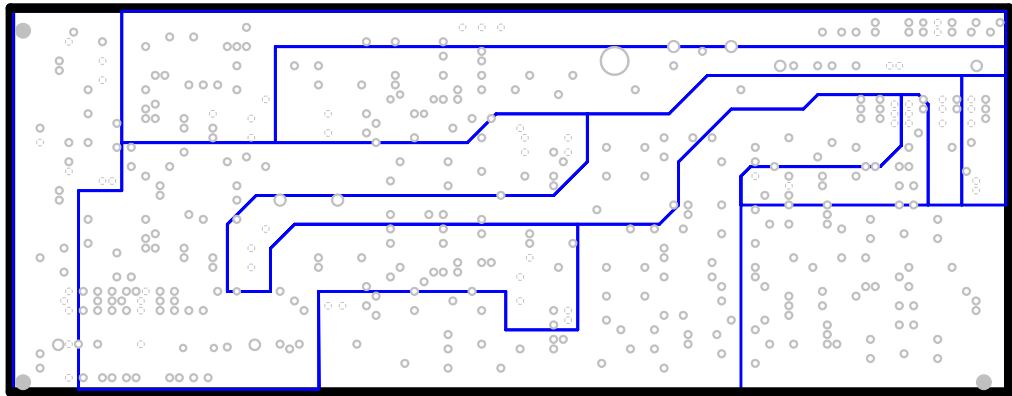

PLANE POWER (LAYER-3)

POSITIVE IMAGE WHEN BOX IS FILLED

National Optical Astronomy Observatory

Drawing Number: TRNT-EL-04-3003 REV A

Next Assy: TRNT-EL-04-1003

TORRENT LCB MEZZANINE BOARD

15DEC09 SH 3 of 10

NOT APPROVED  
FOR CONSTRUCTION  
12-15-09

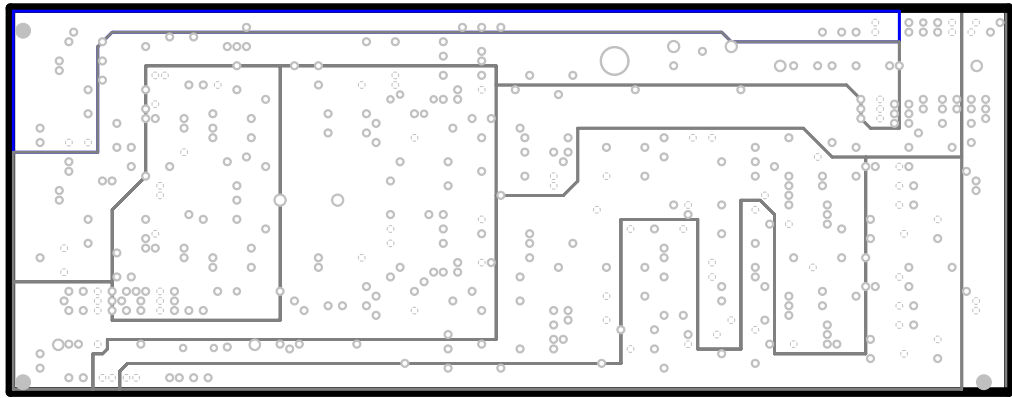

POWER PLANE 2 (LAYER-5)  
POSITIVE IMAGE WHEN BOX IS FILLED

National Optical Astronomy Observatory  
Drawing Number: TRNT-EL-04-3003 REV A  
Next Assy: TRNT-EL-04-1003  
TORRENT LCB MEZZANINE BOARD 15DEC09 SH 5 of 10

NOT APPROVED  
FOR CONSTRUCTION  
12-15-09

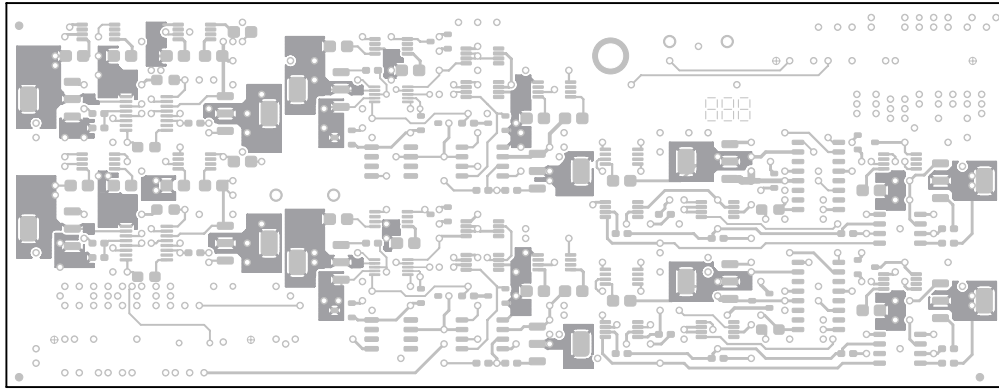

ΥΡΑΠΝΟϚΞ (θ-ϚΕΥΛ) ϚΥΟΤϚΥΠΝΟϚ ΕΠΙΣ ΜΟΤΟΒ  
BOTTOM SIDE CONDUCTOR (LAYER-θ) SECONDARY  
POSITIVE IMAGE WHEN BOX IS FILLED ■

National Optical Astronomy Observatory  
Drawing Number: TRNT-EL-04-3003 REV A  
Next Assy: TRNT-EL-04-1003  
TORRENT LCB MEZZANINE BOARD 15DEC09 SH 6 of 10

NOT APPROVED  
FOR CONSTRUCTION  
12-15-09

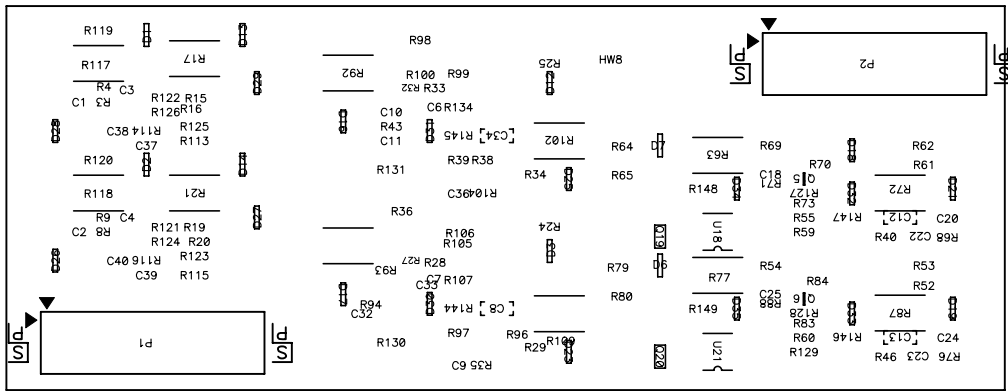

SILKSCREEN TOP (LAYER-1S) PRIMARY  
 POSITIVE IMAGE WHEN BOX IS FILLED ■

National Optical Astronomy Observatory  
 Drawing Number: TRNT-EL-04-3003 REV A  
 Next Assy: TRNT-EL-04-1003  
 TORRENT LCB MEZZANINE BOARD 15DEC09 SH 9 of 10

NOT APPROVED  
 FOR CONSTRUCTION  
 12-15-09

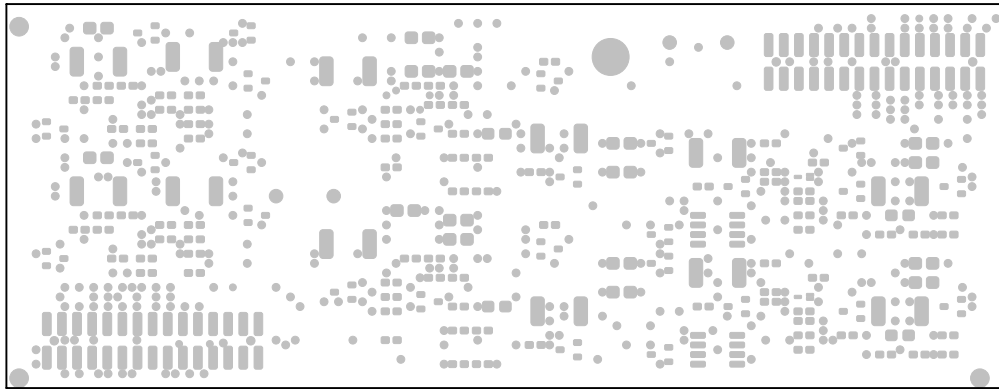

SOLDERMASK TOP (LAYER-1M) PRIMARY  
POSITIVE IMAGE WHEN BOX IS FILLED

National Optical Astronomy Observatory  
Drawing Number: TRNT-EL-04-3003 REV A  
Next Assy: TRNT-EL-04-1003  
TORRENT LCB MEZZANINE BOARD 15DEC09 SH 7 of 10

NOT APPROVED  
FOR CONSTRUCTION  
12-15-09



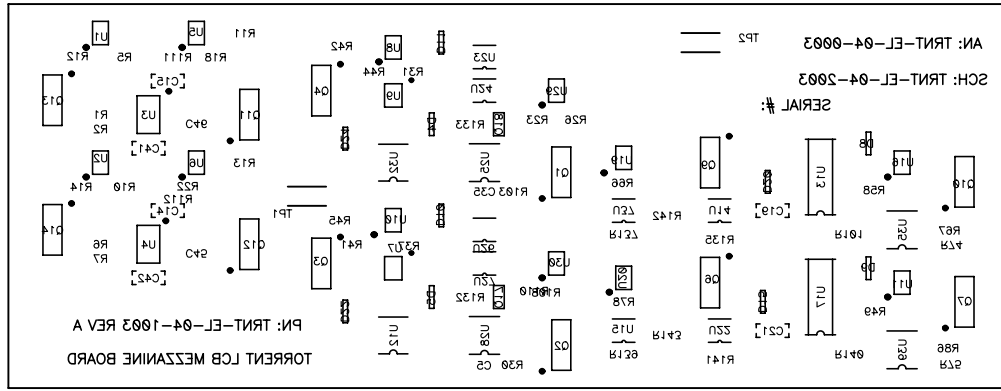

YLKSCREEN BOTTOM (LAYER-02) SECONDARY  
 POSITIVE IMAGE WHEN BOX IS FILLED ■

National Optical Astronomy Observatory  
 Drawing Number: TRNT-EL-04-3003 REV A  
 Next Assy: TRNT-EL-04-1003  
 TORRENT LCB MEZZANINE BOARD 15DEC09 SH 10 of 10

NOT APPROVED  
 FOR CONSTRUCTION  
 12-15-09

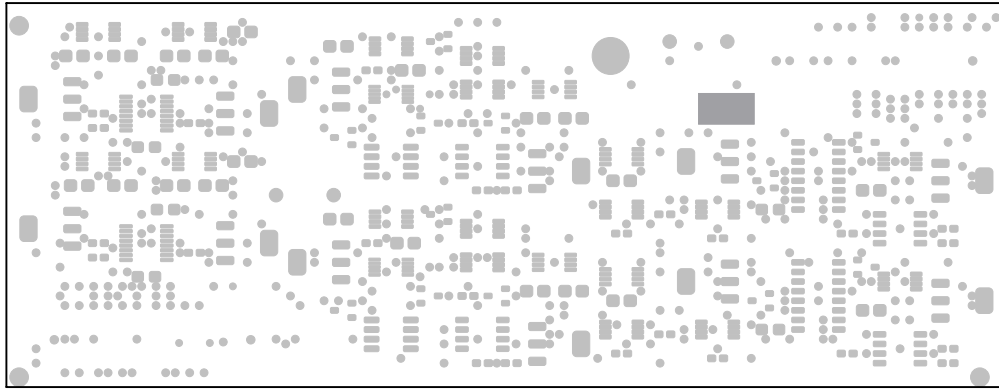

УРАДИНОСЗ (МӨ-РЕЯЛ) МОТТОБ КЗАМЯЭДЛОЗ  
POSITIVE IMAGE WHEN BOX IS FILLED

National Optical Astronomy Observatory  
Drawing Number: TRNT-EL-04-3003 REV A  
Next Assy: TRNT-EL-04-1003  
TORRENT LCB MEZZANINE BOARD 15DEC09 SH 8 of 10

NOT APPROVED  
FOR CONSTRUCTION  
12-15-09