

# VIB-A 1.0

## Dark Energy Survey

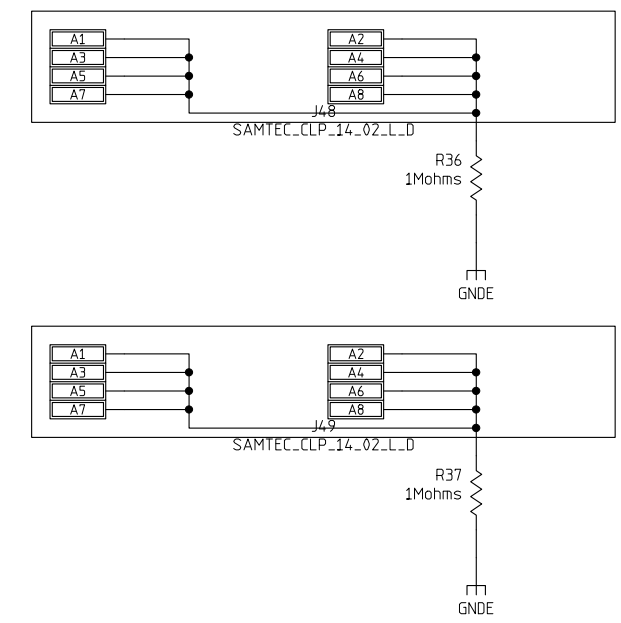

CB1\_2

CLOCK SIGNALS

Clock Board: 1

CCDs: 1S 2S 3S 8S 9S  
14S 15S 20S 25S

MODIFIED 5/27/2009 9:15:00 AM			
EED Department	ORIGINATOR	Walter Stuermer	DATE 3/17/200
	DRAWN	drawn	DATE date
	CHECKED	checked	DATE date
	APPROVED	approved	DATE date
<b>Fermi National Accelerator Laboratory</b> United States Department of Energy			
U:\CAD Projects\DES Cad Projects\PPD_JOBS\DES_FP5_VIB-A\DES_FP5_VIB-A.prj			
SIZE	DRAWING NUMBER	Schematic Page 01 of 14	REV
D	0000-ED-173627		A

# VIB-A 1.0 Dark Energy Survey

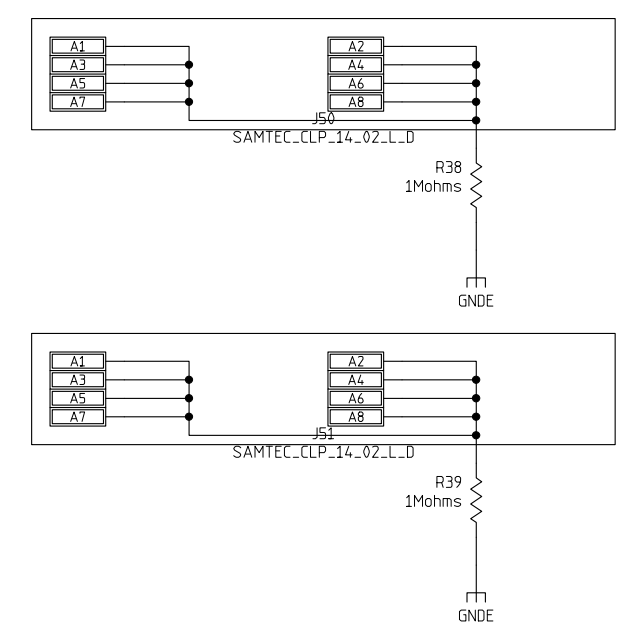
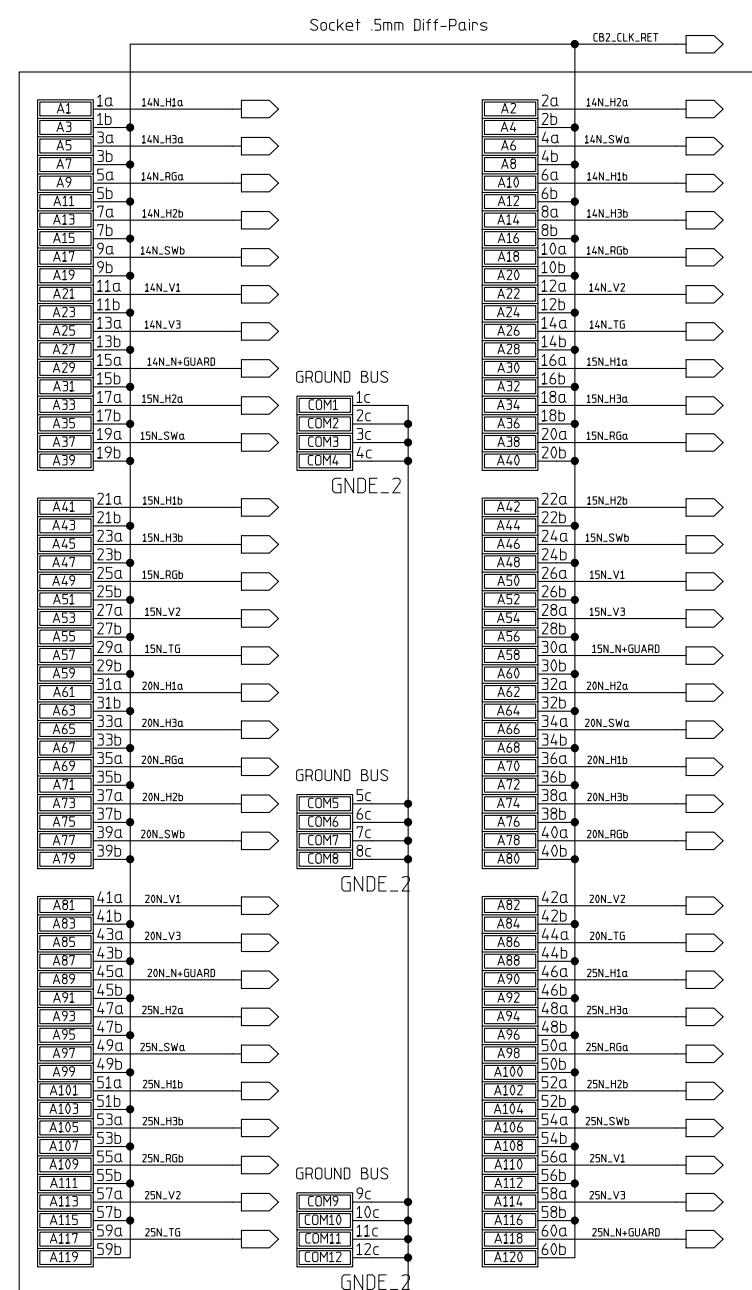
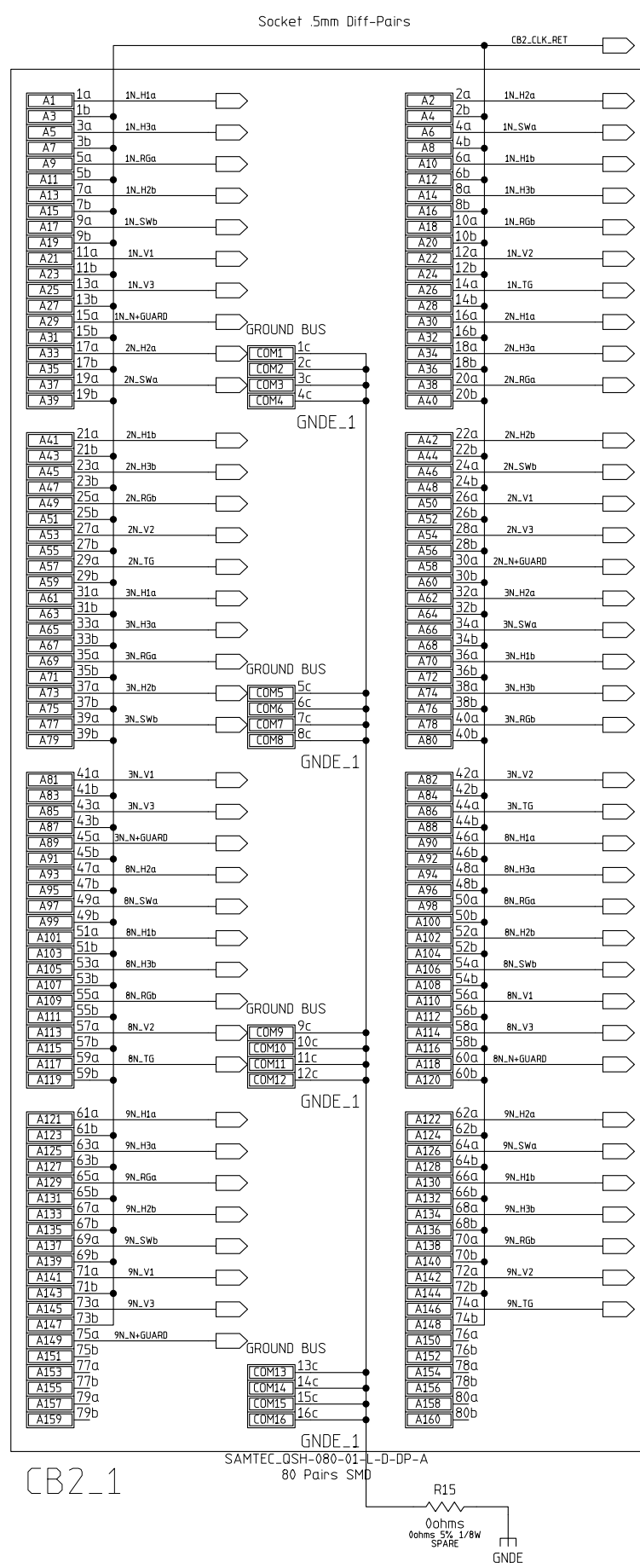

## CLOCK SIGNALS

Clock Board: 2

CCDs: 1N 2N 3N 8N 9N  
14N 15N 20N 25N

MODIFIED 5/27/2009 9:15:00 AM			
EED Department	ORIGINATOR	Walter Stuermer	DATE 3/17/200
	DRAWN	drawn	DATE date
	CHECKED	checked	DATE date
	APPROVED	approved	DATE date
 <b>Fermi National Accelerator Laboratory</b> United States Department of Energy			
U:\CAD Projects\DES Cad Projects\PPP05\DES_FP5_VIB-A\DES_FP5_VIB-A.prj			
SIZE	DRAWING NUMBER	Schematic Page 02 of 14	REV
D	0000-ED-173627		A

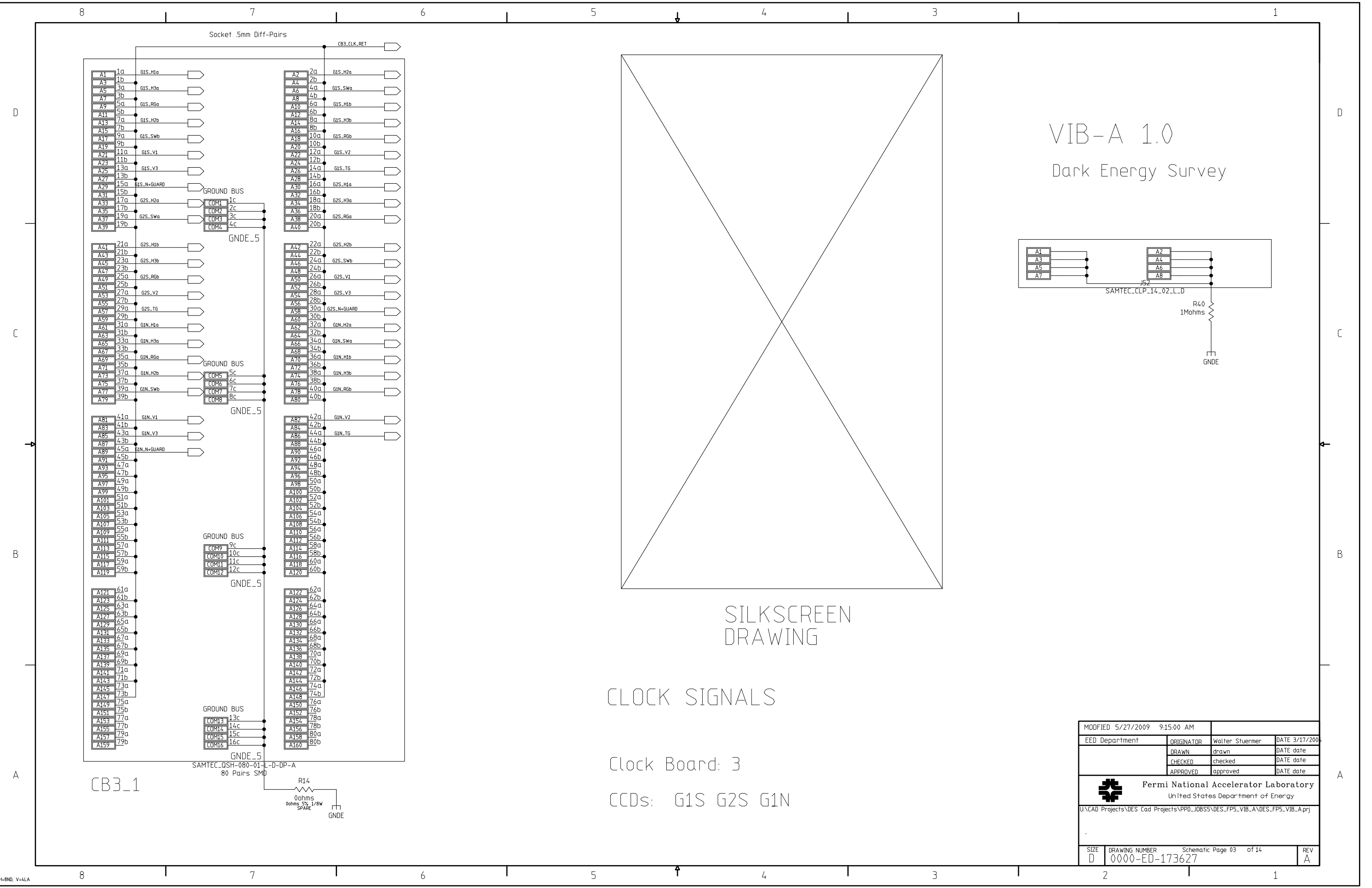

VIB-A 1.0  
Dark Energy Survey

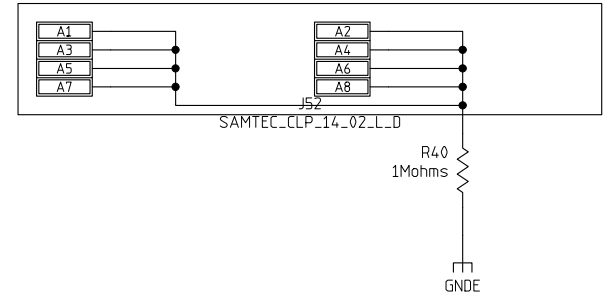

SILKSCREEN  
DRAWING

CLOCK SIGNALS

Clock Board: 3

CCDs: G1S G2S G1N

MODIFIED 5/27/2009 9:15:00 AM			
EED Department	ORIGINATOR	Walter Stuermer	DATE 3/17/200
	DRAWN	drawn	DATE date
	CHECKED	checked	DATE date
	APPROVED	approved	DATE date
 <b>Fermi National Accelerator Laboratory</b> United States Department of Energy			
U:\CAD Projects\DES Cad Projects\PPD_JOBS\DES_FP5_VIB_A\DES_FP5_VIB_A.prj			
SIZE	DRAWING NUMBER	Schematic Page 03 of 14	REV
D	0000-ED-173627		A

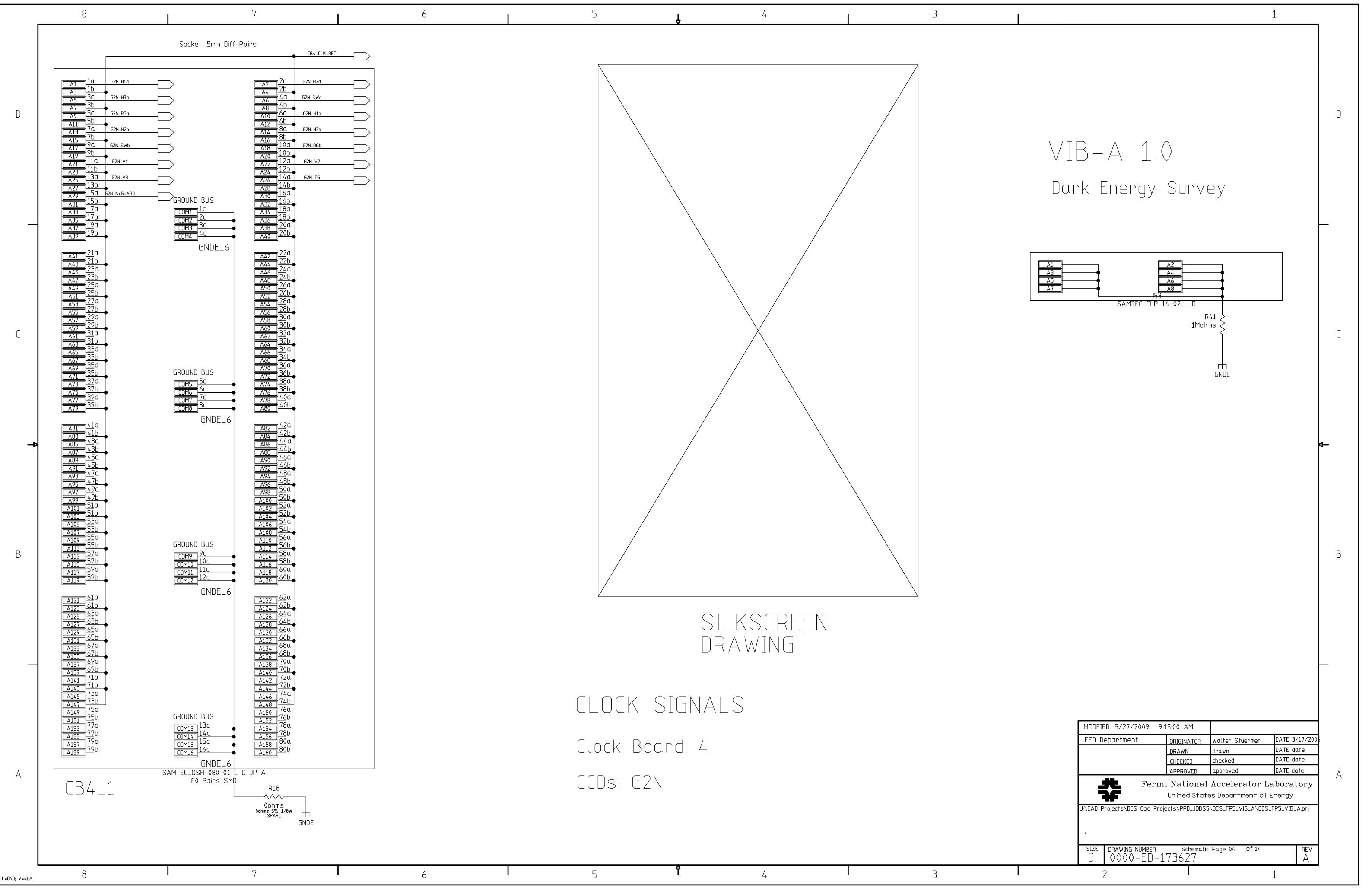

VIB-A 1.0  
Dark Energy Survey

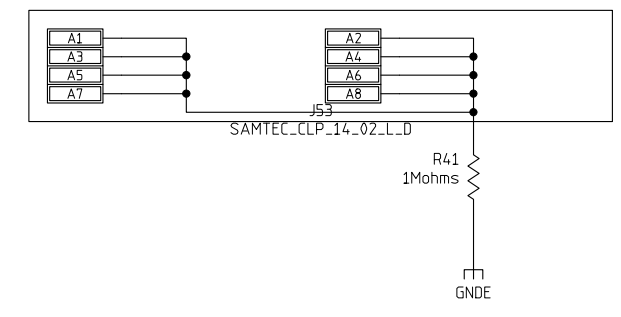

SILKSCREEN  
DRAWING

CLOCK SIGNALS

Clock Board: 4

CCDs: G2N

MODIFIED 5/27/2009 9:15:00 AM			
EED Department	ORIGINATOR	Walter Stuermer	DATE 3/17/200
	DRAWN	drawn	DATE date
	CHECKED	checked	DATE date
	APPROVED	approved	DATE date
 <b>Fermi National Accelerator Laboratory</b> United States Department of Energy			
U:\CAD Projects\DES Cad Projects\PPP\JOBS\DES_FP5_VIB_A\DES_FP5_VIB_A.prj			
SIZE	DRAWING NUMBER	Schematic Page 04 of 14	REV
D	0000-ED-173627		A

SAMTEC\_HSEC8-137-01-S-DV-A

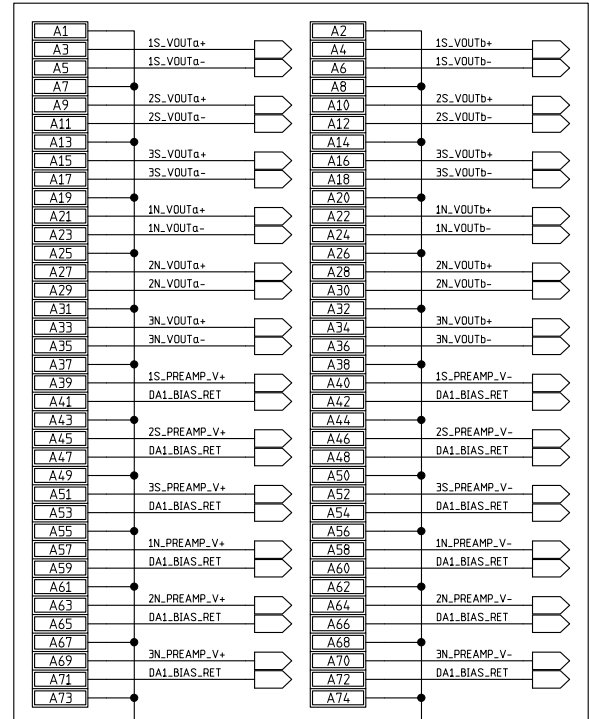

DA1\_2

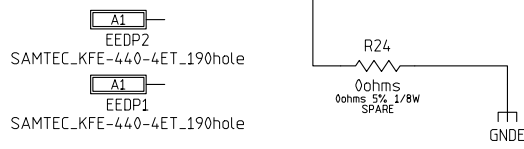

VIDEO SIGNALS

SAMTEC\_HSEC8-125-01-S-DV-A

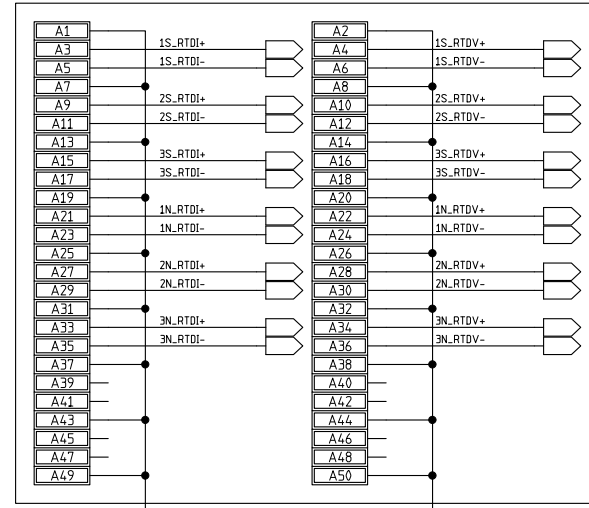

DA1\_3

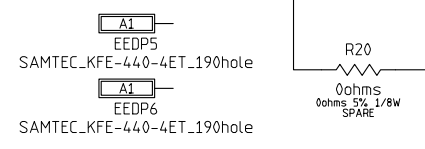

RTD SIGNALS

SAMTEC\_HSEC8-149-01-S-DV-A

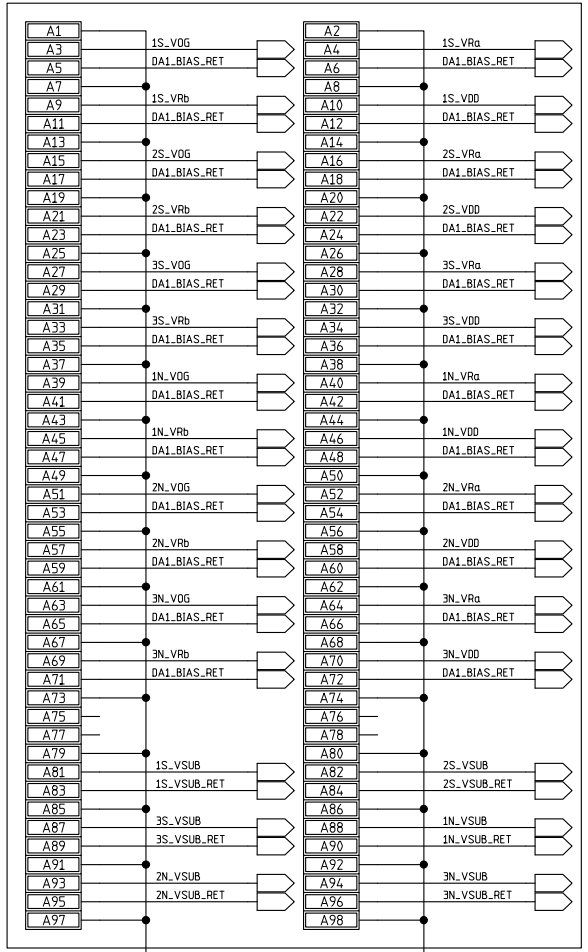

DA1\_1

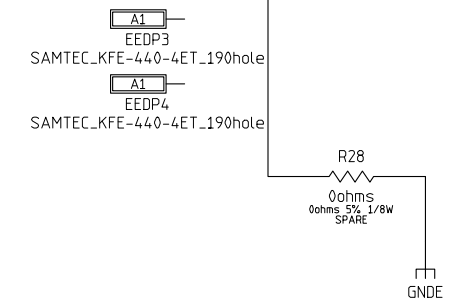

BIAS SIGNALS

# VIB-A 1.0

## Dark Energy Survey

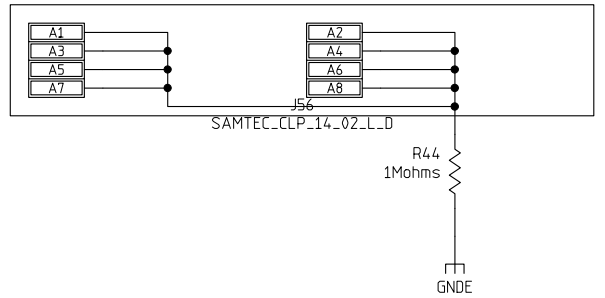
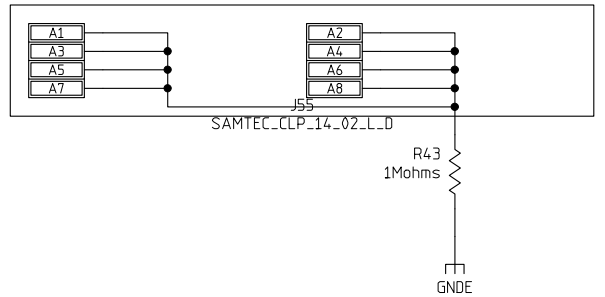
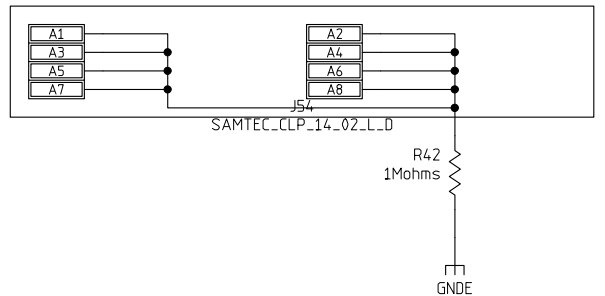

Data Acquisition Board: 1  
CCDs: 1S 2S 3S 1N 2N 3N

MODIFIED 5/27/2009 9:15:00 AM			
EED Department	ORIGINATOR	Walter Stuermer	DATE 3/17/200
	DRAWN	drawn	DATE date
	CHECKED	checked	DATE date
	APPROVED	approved	DATE date
 <b>Fermi National Accelerator Laboratory</b> United States Department of Energy			
U:\CAD Projects\DES Cad Projects\PPP0_JOBS5\DES_FP5_VIB-A\DES_FP5_VIB-A.prj			
SIZE	DRAWING NUMBER	Schematic Page 05 of 14	REV
D	0000-ED-173627		A

# VIB-A 1.0

## Dark Energy Survey

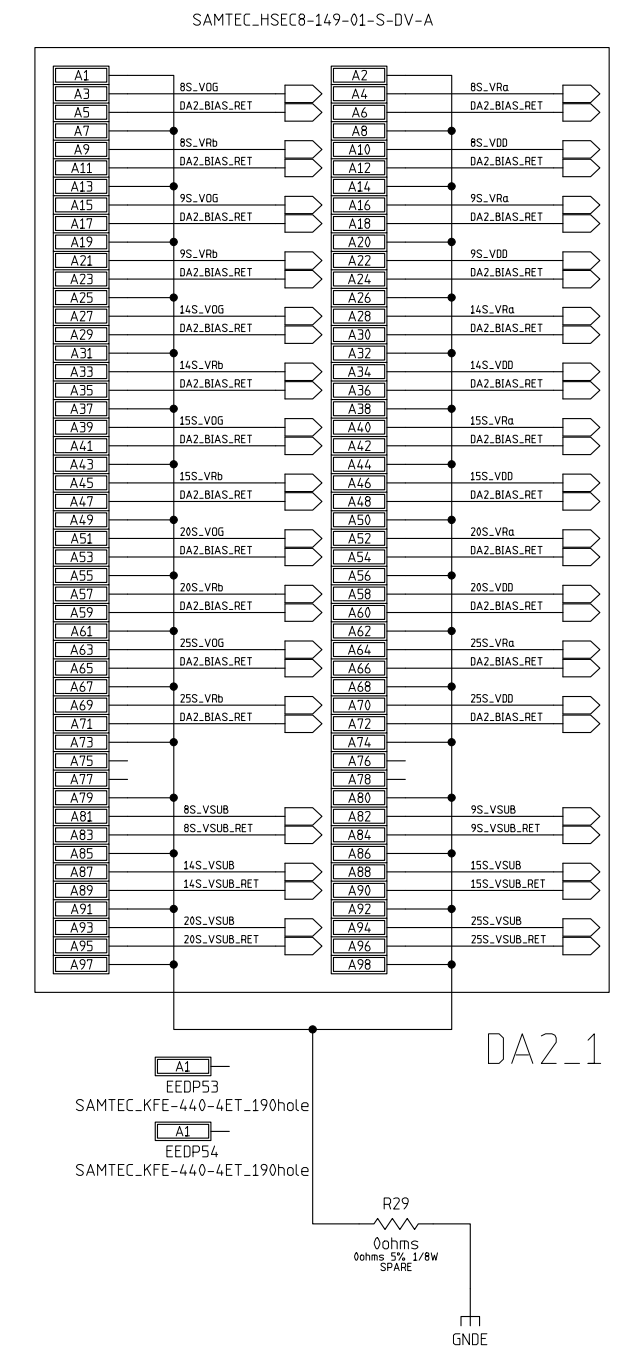
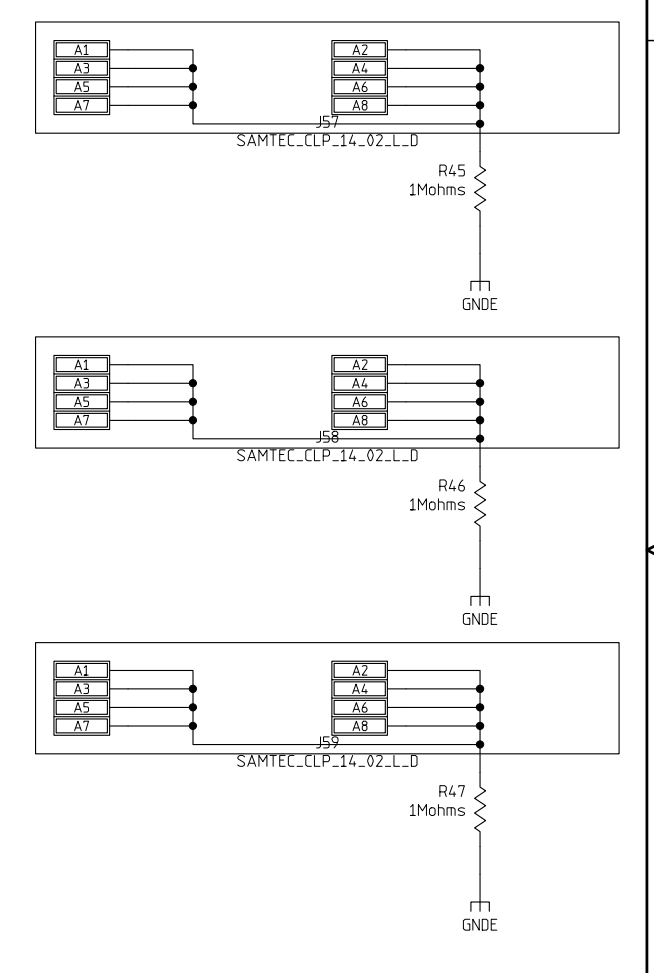

### BIAS SIGNALS

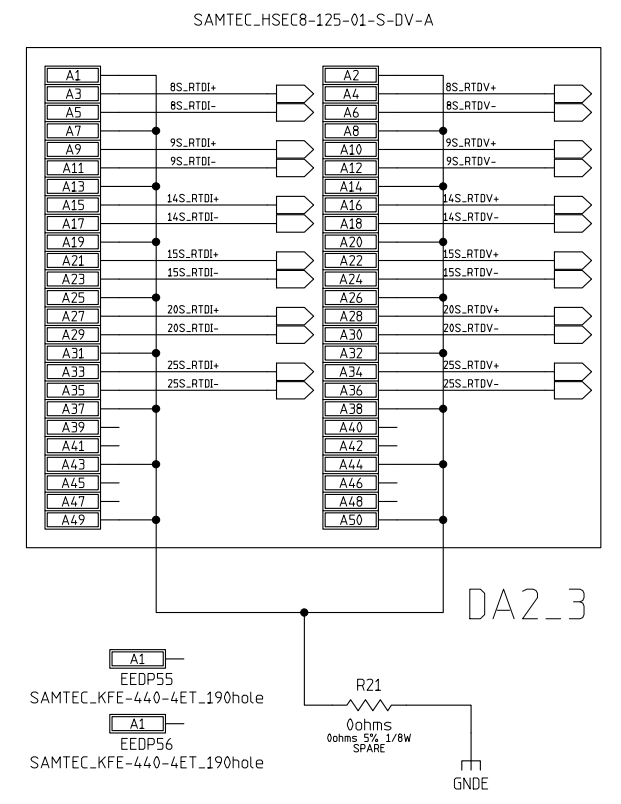

### RTD SIGNALS

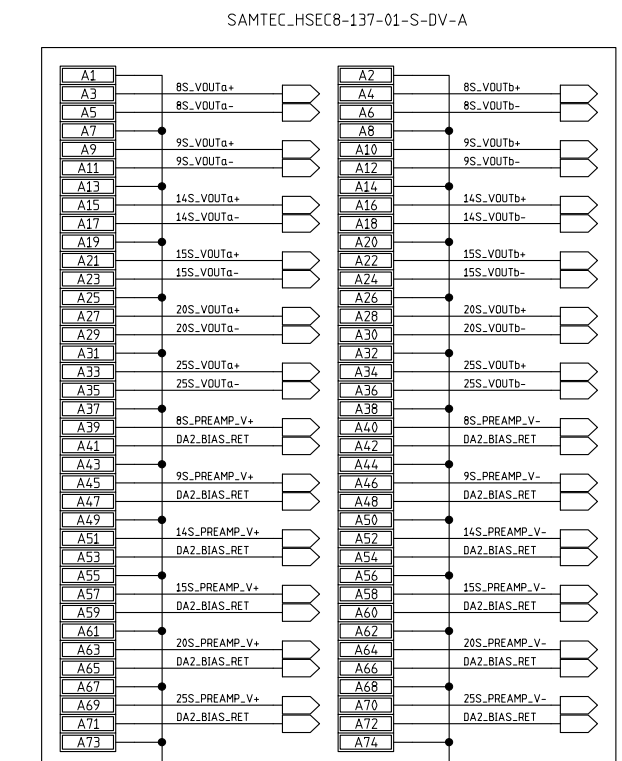
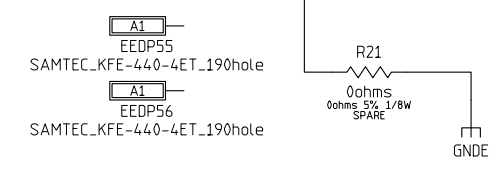

### VIDEO SIGNALS

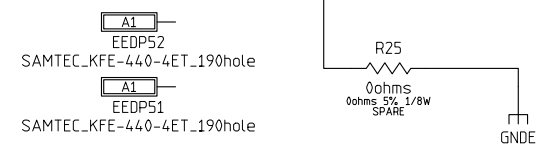

Data Acquisition Board: 2  
 CCDs: 8S 9S 14S 15S 20S 25S

MODIFIED 5/27/2009 9:15:00 AM			
EED Department	ORIGINATOR	Walter Stuermer	DATE 3/17/200
	DRAWN	drawn	DATE date
	CHECKED	checked	DATE date
	APPROVED	approved	DATE date
 <b>Fermi National Accelerator Laboratory</b> United States Department of Energy			
U:\CAD Projects\DES Cad Projects\PPD_JOBS\DES_FP5_VIB_A\DES_FP5_VIB_A.prj			
SIZE	DRAWING NUMBER	Schematic Page 06 of 14	REV
D	0000-ED-173627		A

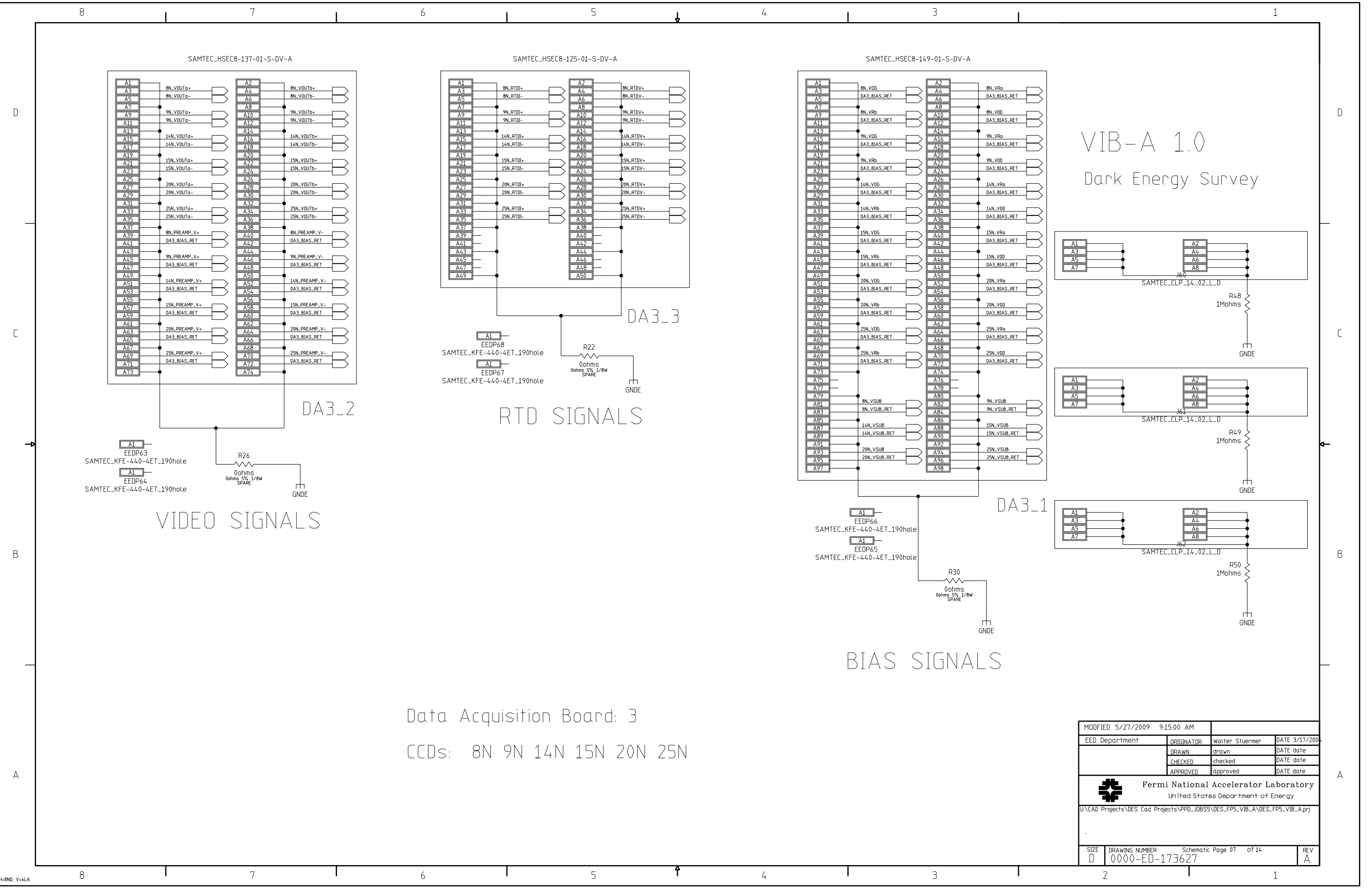

VIB-A 1.0  
Dark Energy Survey

Data Acquisition Board: 3  
CCDs: 8N 9N 14N 15N 20N 25N

MODIFIED 5/27/2009 9:15:00 AM			
EED Department	ORIGINATOR	Walter Stuermer	DATE 3/17/200
	DRAWN	drawn	DATE date
	CHECKED	checked	DATE date
	APPROVED	approved	DATE date
 <b>Fermi National Accelerator Laboratory</b> United States Department of Energy			
U:\CAD Projects\DES Cad Projects\PPP05\DES_FP5_VIB-A\DES_FP5_VIB-A.prj			
SIZE	DRAWING NUMBER	Schematic Page 07 of 14	REV
D	0000-ED-173627		A

SAMTEC\_HSEC8-137-01-S-DV-A

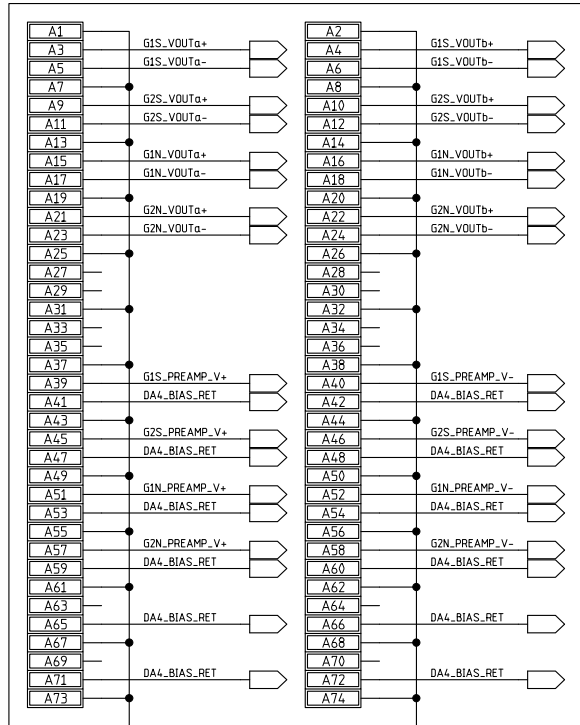

DA4\_2

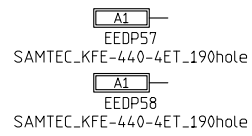

VIDEO SIGNALS

SAMTEC\_HSEC8-125-01-S-DV-A

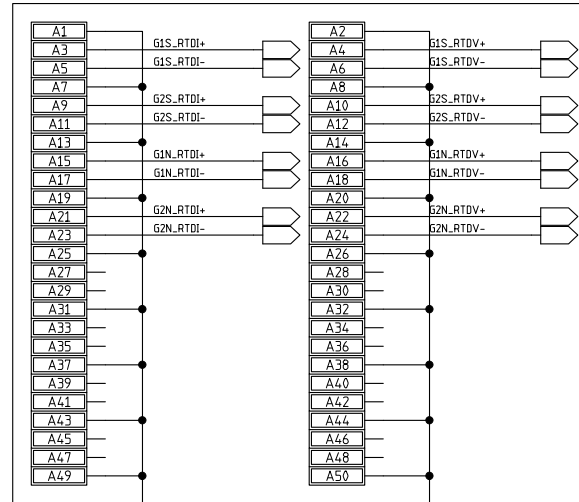

DA4\_3

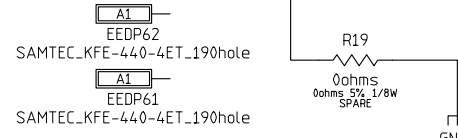

RTD SIGNALS

SAMTEC\_HSEC8-149-01-S-DV-A

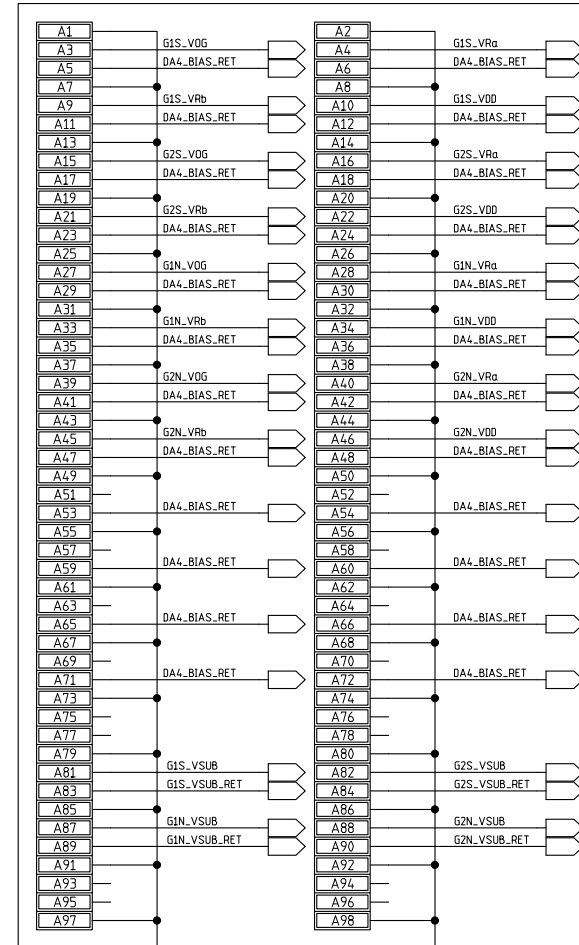

DA4\_1

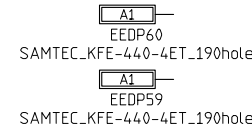

BIAS SIGNALS

# VIB-A 1.0 Dark Energy Survey

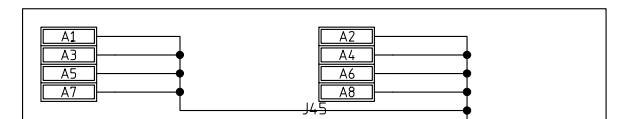
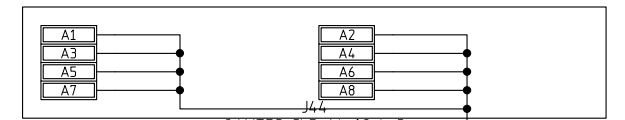
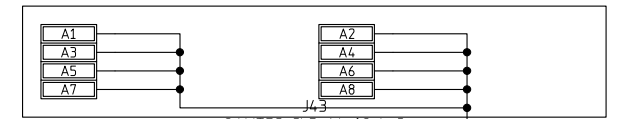

Data Acquisition Board: 4  
CCDs: G1S G2S G1N G2N

MODIFIED 5/27/2009 9:15:00 AM			
EED Department	ORIGINATOR	Walter Stuermer	DATE 3/17/200
	DRAWN	drawn	DATE date
	CHECKED	checked	DATE date
	APPROVED	approved	DATE date



Fermi National Accelerator Laboratory  
United States Department of Energy

U:\CAD Projects\DES Cad Projects\PPP05\DES\_FP5\_VIB-A\DES\_FP5\_VIB-A.prj

SIZE	DRAWING NUMBER	Schematic Page 08 of 14	REV
D	0000-ED-173627		A



# VIB-A 1.0

## Dark Energy Survey

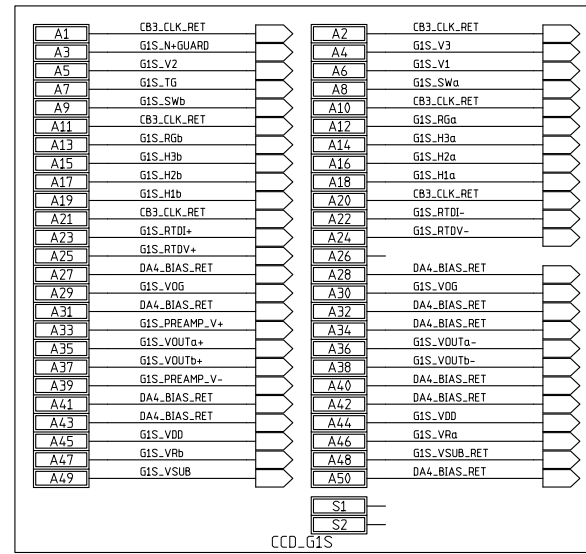

CCD G1S AMP 104550-6  
 CB 3 DA 4  
 A1 EEDP7  
 A1 EEDP9

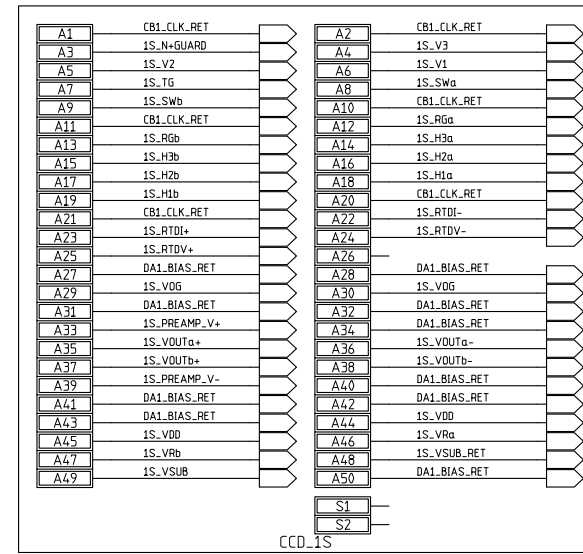

CCD 1S AMP 104550-6  
 CB 1 DA 1  
 A1 EEDP10  
 A1 EEDP13

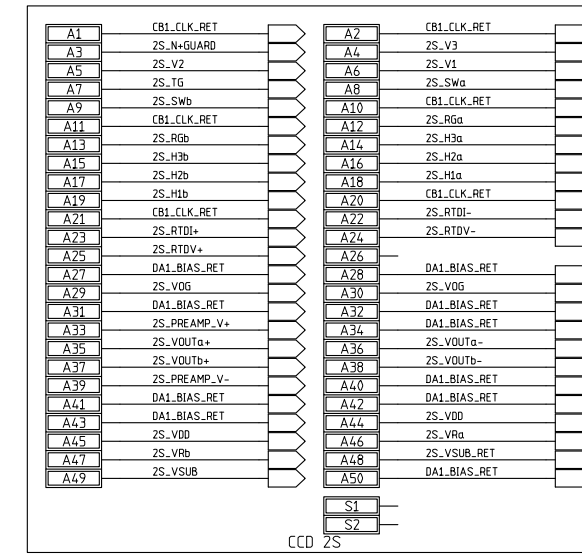

CCD 2S AMP 104550-6  
 CB 1 DA 1  
 A1 EEDP14  
 A1 EEDP17

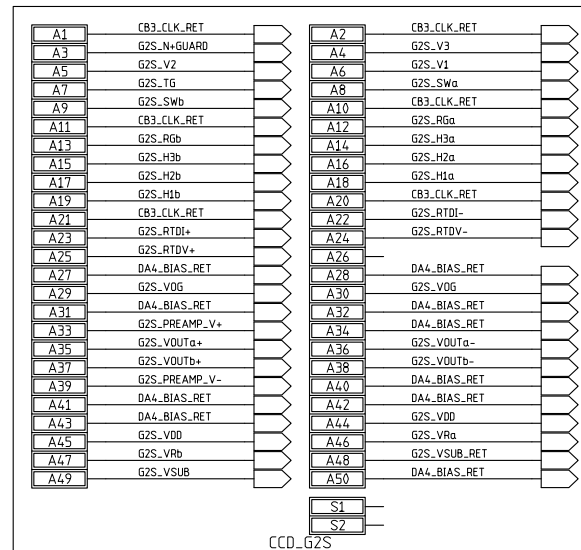

CCD G2S AMP 104550-6  
 CB 3 DA 4  
 A1 EEDP11

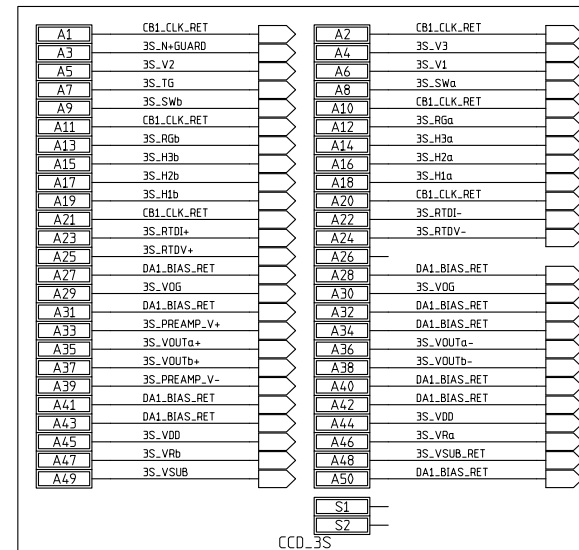

CCD 3S AMP 104550-6  
 CB 1 DA 1  
 A1 EEDP12  
 A1 EEDP15

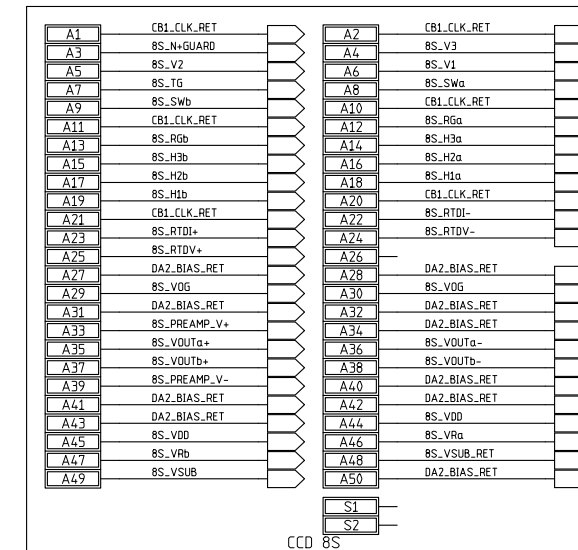

CCD 8S AMP 104550-6  
 CB 1 DA 2  
 A1 EEDP16  
 A1 EEDP19

### VIB-INTERFACE CARDS

MODIFIED 5/27/2009 9:15:00 AM			
EED Department	ORIGINATOR	Walter Stuermer	DATE 3/17/200
	DRAWN	drawn	DATE date
	CHECKED	checked	DATE date
	APPROVED	approved	DATE date
 <b>Fermi National Accelerator Laboratory</b> United States Department of Energy			
U:\CAD Projects\DES Cad Projects\PPP5\DES_FP5_VIB-A\DES_FP5_VIB-A.prj			
SIZE	DRAWING NUMBER	Schematic Page 09 of 14	REV
D	0000-ED-173627		A

# VIB-A 1.0

## Dark Energy Survey

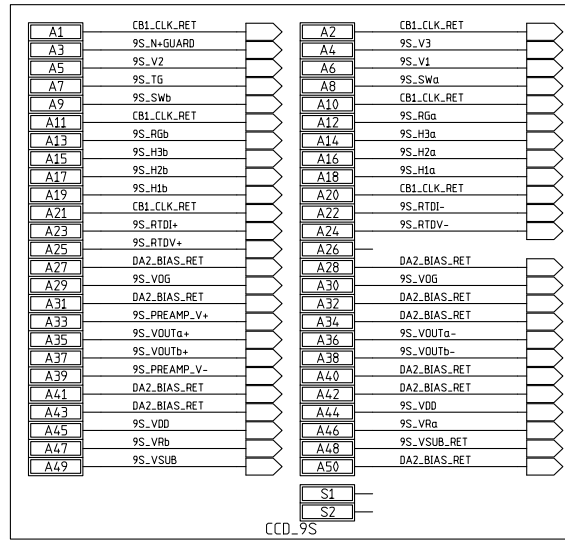

CCD 9S AMP 104550-6  
 CB 1 DA 2

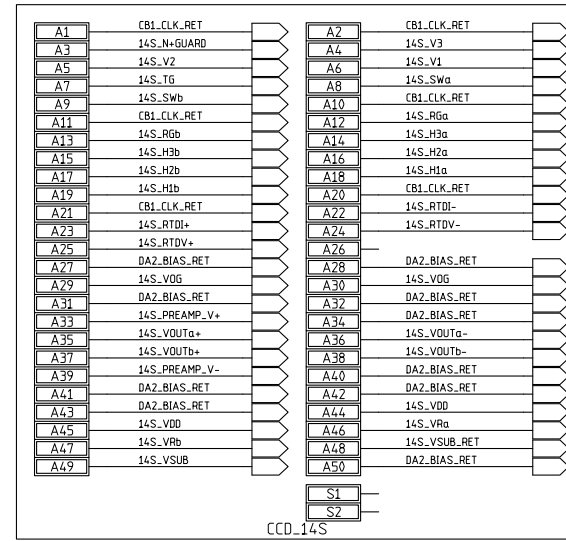

CCD 14S AMP 104550-6  
 CB 1 DA 2

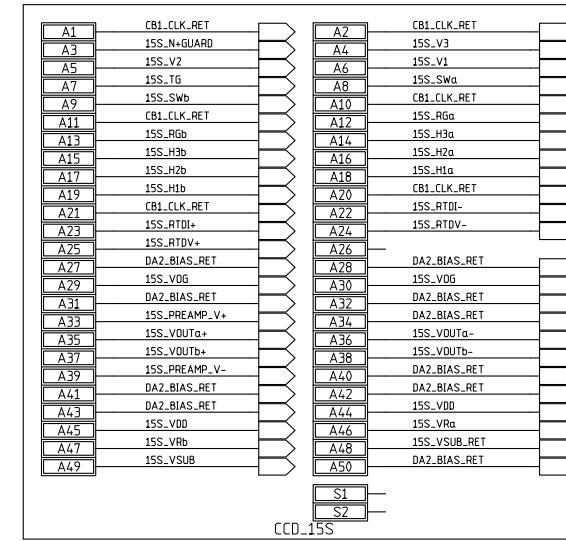

CCD 15S AMP 104550-6  
 CB 1 DA 2

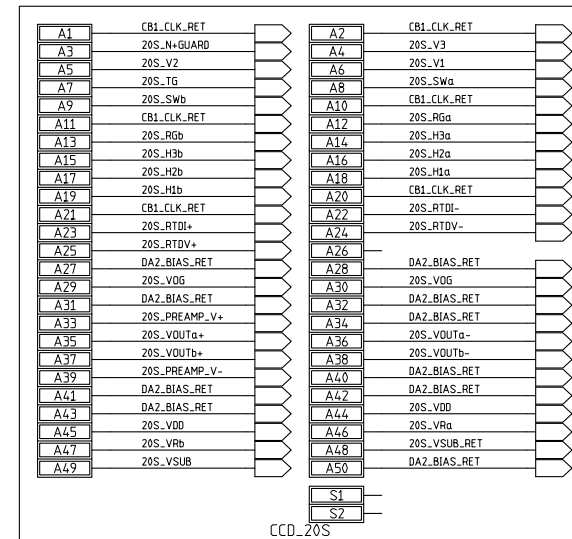

CCD 20S AMP 104550-6  
 CB 1 DA 2

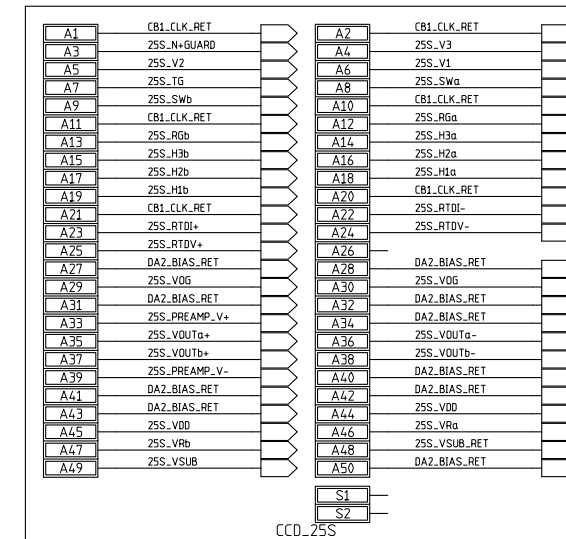

CCD 25S AMP 104550-6  
 CB 1 DA 2

### VIB-INTERFACE CARDS

MODIFIED 5/27/2009 9:15:00 AM			
EED Department	ORIGINATOR	Walter Stuermer	DATE 3/17/2008
	DRAWN	drawn	DATE date
	CHECKED	checked	DATE date
	APPROVED	approved	DATE date
 <b>Fermi National Accelerator Laboratory</b> United States Department of Energy			
U:\CAD Projects\DES Cad Projects\PPD_JOBS5\DES_FP5_VIB_A\DES_FP5_VIB_A.prj			
SIZE	DRAWING NUMBER	Schematic Page 10 of 14	REV
D	0000-ED-173627		A

# VIB-A 1.0

## Dark Energy Survey

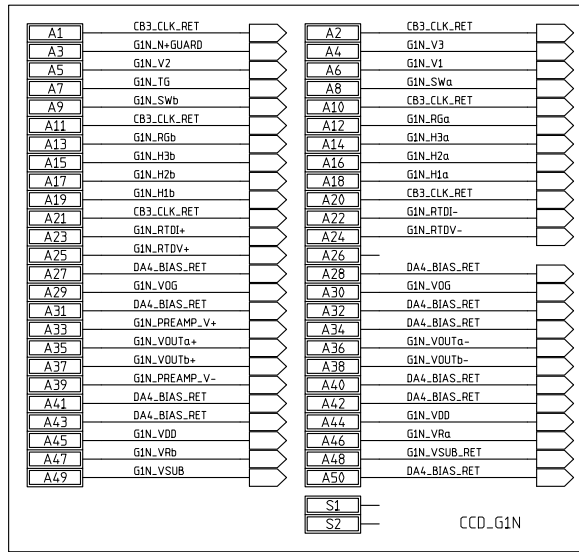

CCD G1N AMP 104550-6 EEDP30  
CB 3 DA 4 EEDP29

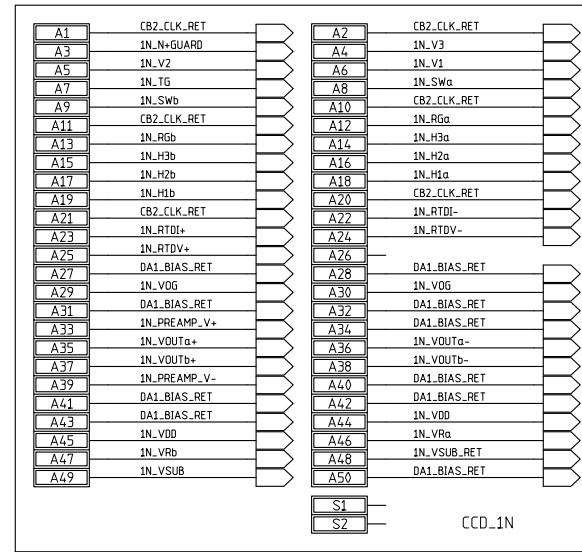

CCD 1N AMP 104550-6 EEDP34

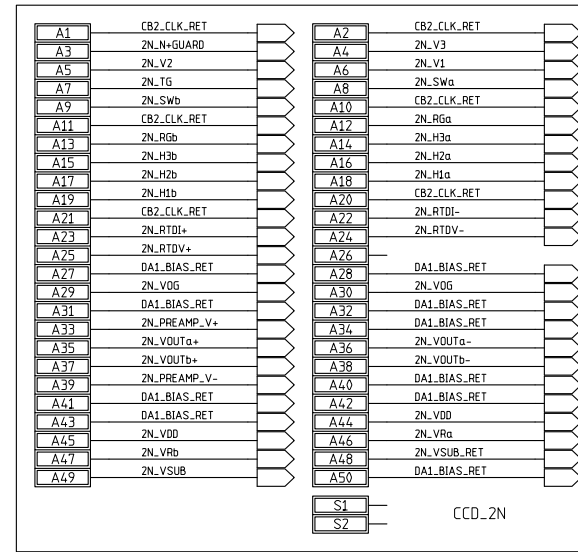

CCD 2N AMP 104550-6

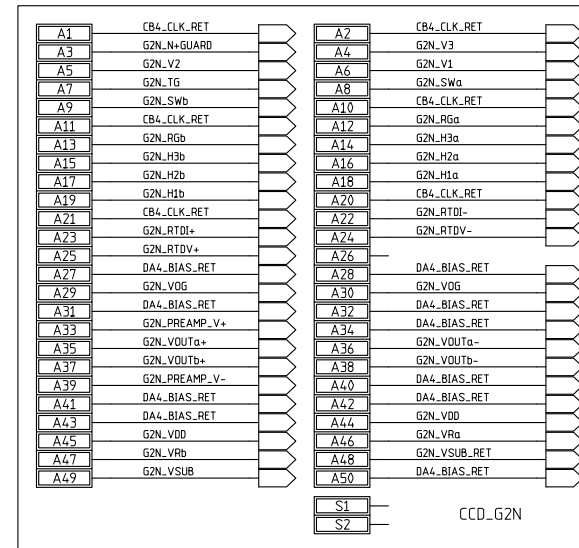

CCD G2N AMP 104550-6 EEDP31

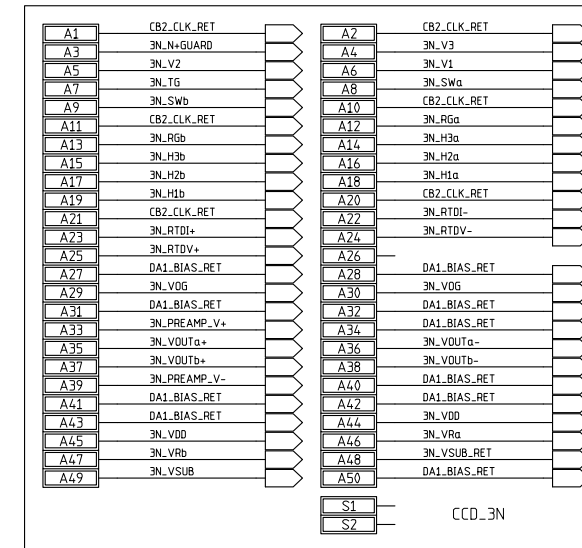

CCD 3N AMP 104550-6

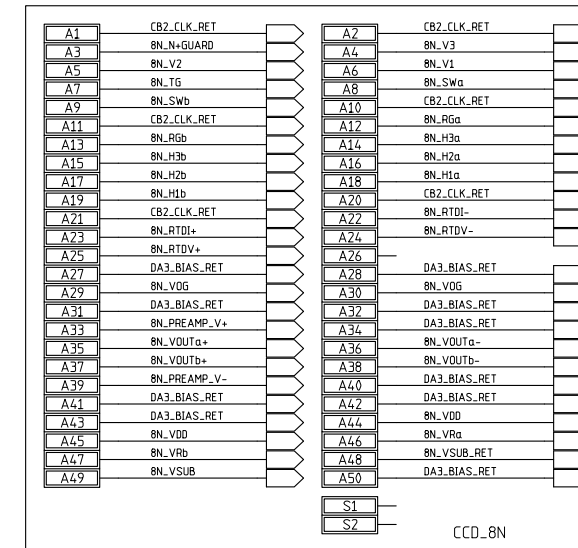

CCD 8N AMP 104550-6

### VIB-INTERFACE CARDS

MODIFIED 5/27/2009 9:15:00 AM			
EED Department	ORIGINATOR	Walter Stuermer	DATE 3/17/200
	DRAWN	drawn	DATE date
	CHECKED	checked	DATE date
	APPROVED	approved	DATE date
 <b>Fermi National Accelerator Laboratory</b> United States Department of Energy			
U:\CAD Projects\DES Cad Projects\PPP05\DES_FP5_VIB-A\DES_FP5_VIB-A.prj			
SIZE	DRAWING NUMBER	Schematic Page 11 of 14	REV
D	0000-ED-173627		A

# VIB-A 1.0

## Dark Energy Survey

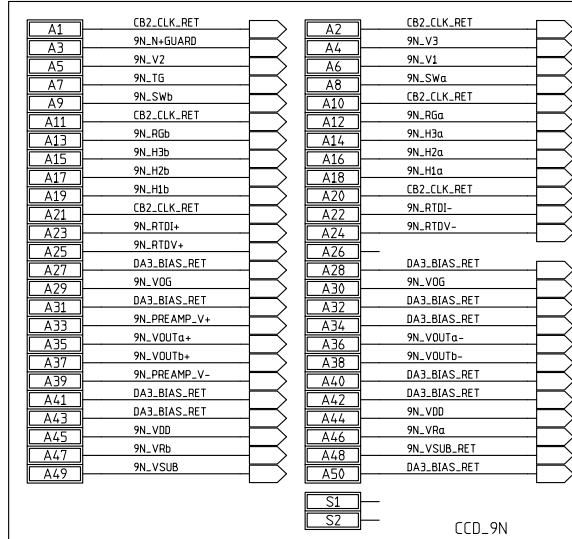

CCD 9N AMP 104550-6  
 CB 2 DA 3

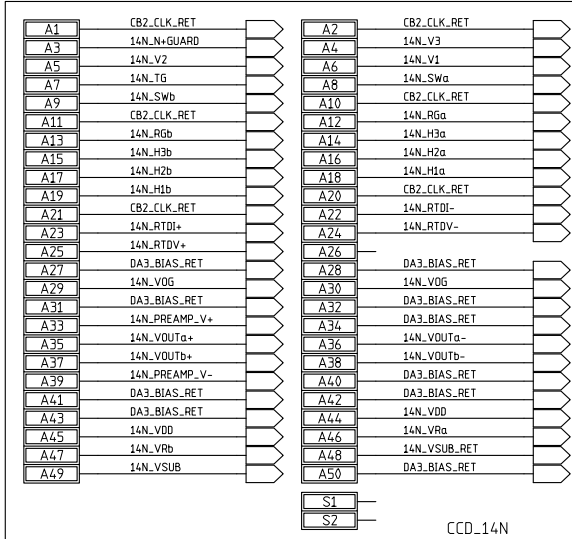

CCD 14N AMP 104550-6  
 CB 2 DA 3

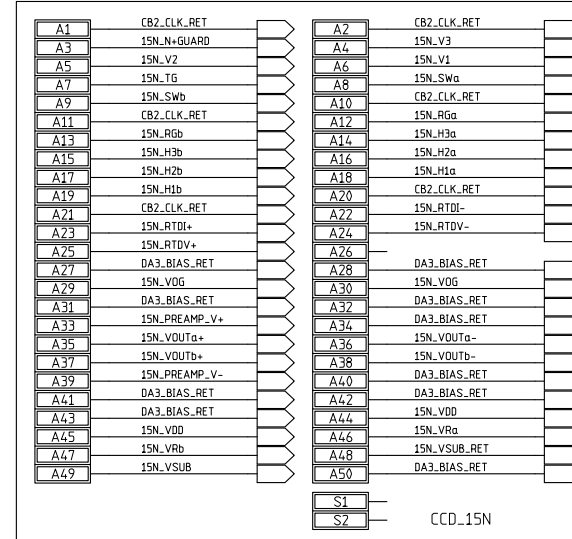

CCD 15N AMP 104550-6  
 CB 2 DA 3

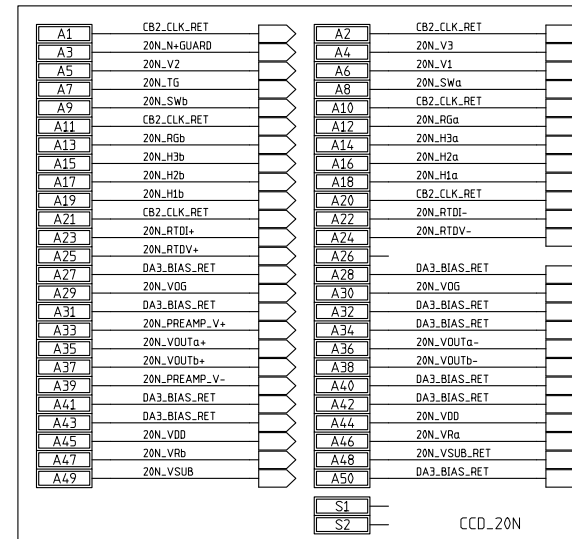

CCD 20N AMP 104550-6  
 CB 2 DA 3

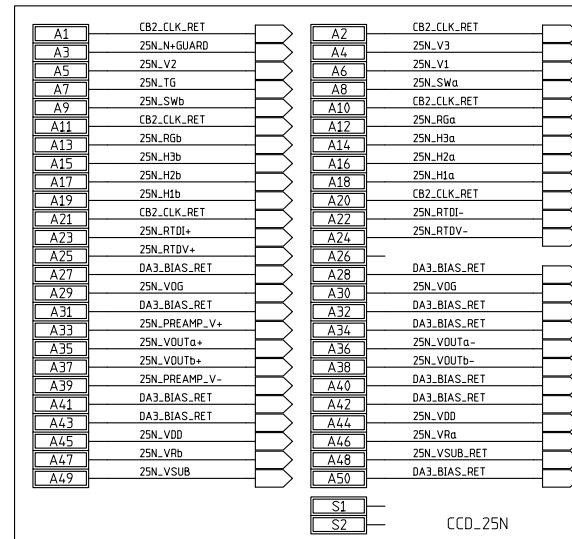

CCD 25N AMP 104550-6  
 CB 2 DA 3

### VIB-INTERFACE CARDS

MODIFIED 5/27/2009 9:15:00 AM			
EED Department	ORIGINATOR	Walter Stuermer	DATE 3/17/2009
	DRAWN	drawn	DATE date
	CHECKED	checked	DATE date
	APPROVED	approved	DATE date
 <b>Fermi National Accelerator Laboratory</b> United States Department of Energy			
U:\CAD Projects\DES Cad Projects\PPD_JOBS5\DES_FP5_VIB-A\DES_FP5_VIB-A.prj			
SIZE	DRAWING NUMBER	Schematic Page 12 of 14	REV
D	0000-ED-173627		A

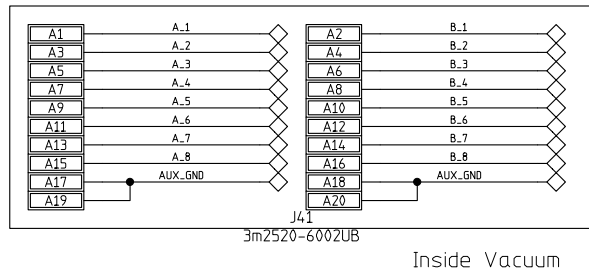
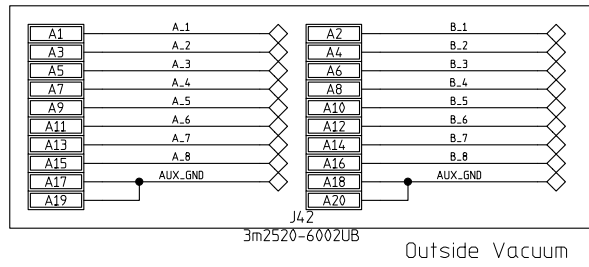

AUX CONNECTOR

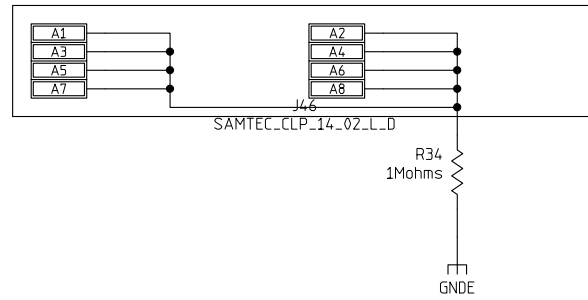

VIB-A 1.0  
Dark Energy Survey

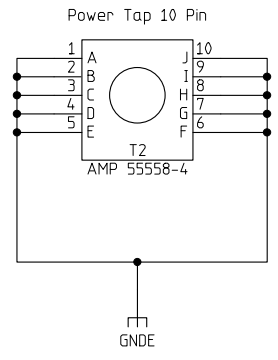
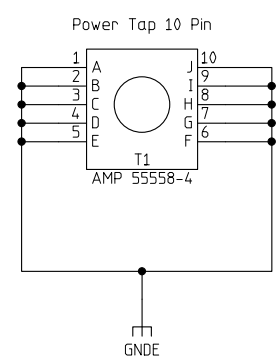

GROUND STRAPS

MODIFIED 5/27/2009 9:15:00 AM			
EED Department	ORIGINATOR	Walter Stuermer	DATE 3/17/200
	DRAWN	drawn	DATE date
	CHECKED	checked	DATE date
	APPROVED	approved	DATE date
 <b>Fermi National Accelerator Laboratory</b> United States Department of Energy			
U:\CAD Projects\DES Cad Projects\PPP0_JOBS5\DES_FP5_VIB-A\DES_FP5_VIB-A.pj			
SIZE	DRAWING NUMBER	Schematic Page 13 of 14	REV
D	0000-ED-173627		A

8

7

6

5

4

3

1

D

D

C

C

B

B

A

A

MODIFIED 5/27/2009 9:15:00 AM			
EED Department	ORIGINATOR	Walter Stuermer	DATE 3/17/2009
	DRAWN	drawn	DATE date
	CHECKED	checked	DATE date
	APPROVED	approved	DATE date
		Fermi National Accelerator Laboratory United States Department of Energy	
U:\CAD Projects\DES Cad Projects\PPP05\DES.FP5_VIB.A\DES.FP5_VIB.A.prj			
SIZE	DRAWING NUMBER	Schematic Page 14 of 14	REV
D	0000-ED-173627		A

8

7

6

5

4

3

2

1