

ALL_SIGNALS

VIB-WEST 2.0
Dark Energy Survey

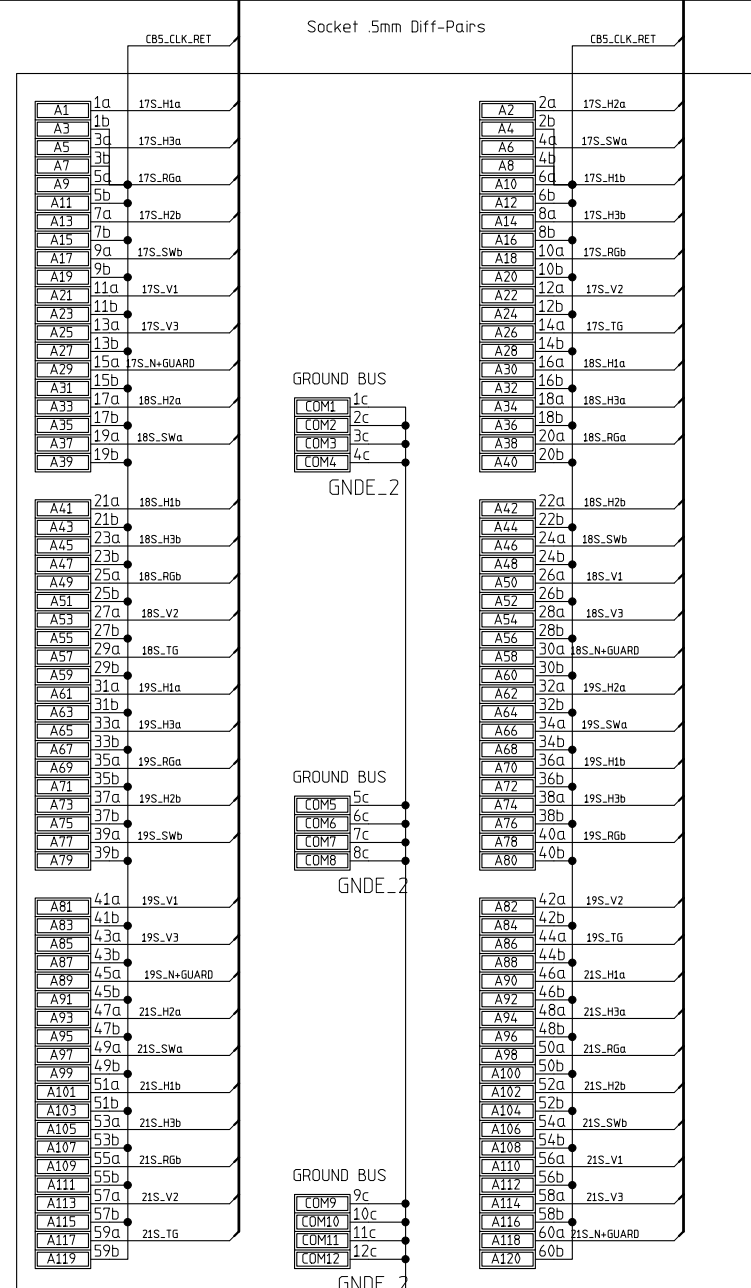
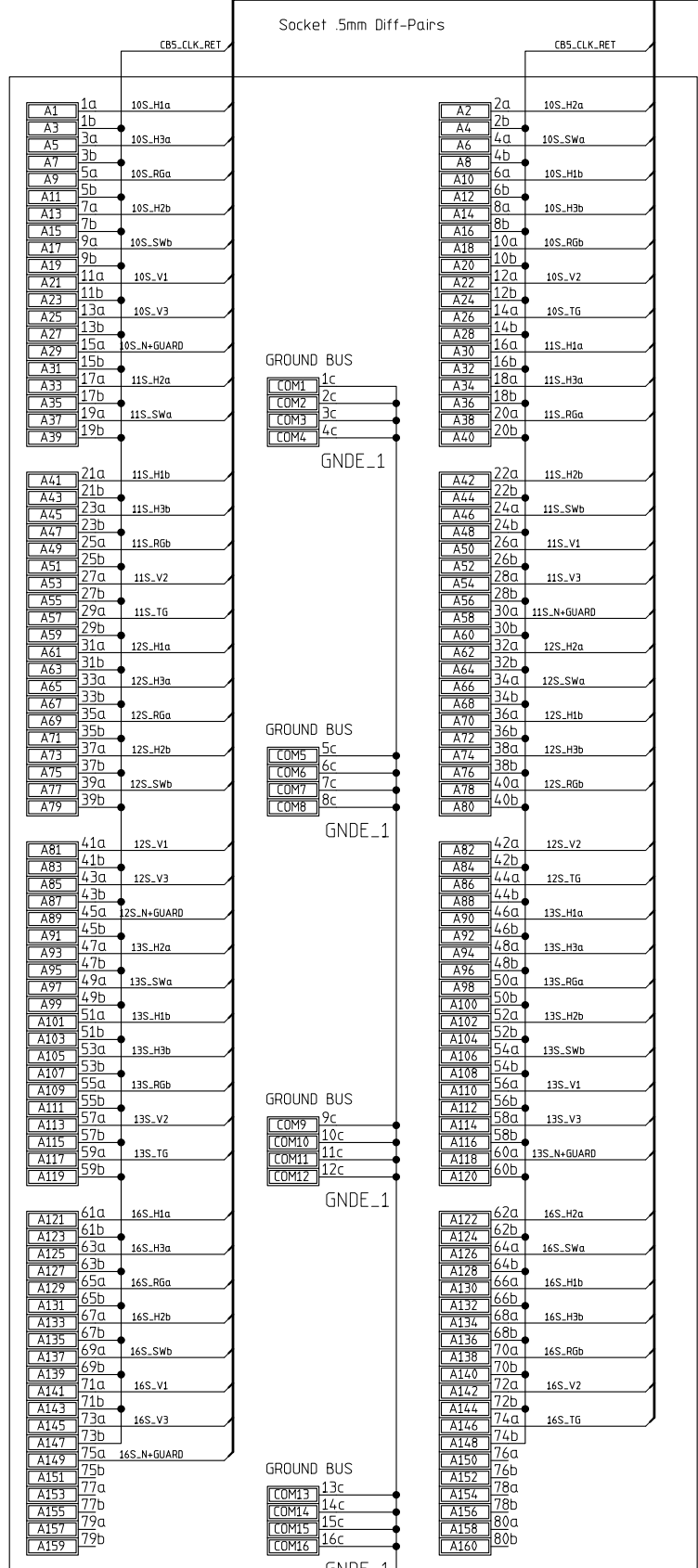

CLOCK SIGNALS

Clock Board: 5

CCDs: 10S 11S 12S 13S 16S
17S 18S 19S 21S

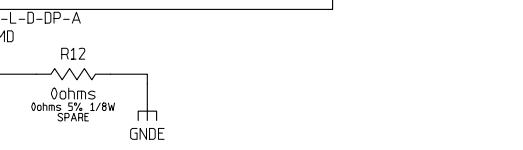

MODIFIED 2/24/2010 11:40:26 AM			
EED Department	ORIGINATOR	Walter Stuermer	DATE 10/26/2009
	DRAWN	drawn	DATE date
	CHECKED	checked	DATE date
	APPROVED	approved	DATE date
 Fermi National Accelerator Laboratory United States Department of Energy			
U:\CAD Projects\DES Cad Projects\PPD_JOBS6\DES_FP5_VIB_B\DES_FP5_VIB_B.pj			
SIZE	DRAWING NUMBER	Schematic Page 01 of 27	REV
D	173694		A

VIB-WEST 2.0 Dark Energy Survey

ALL_SIGNALS

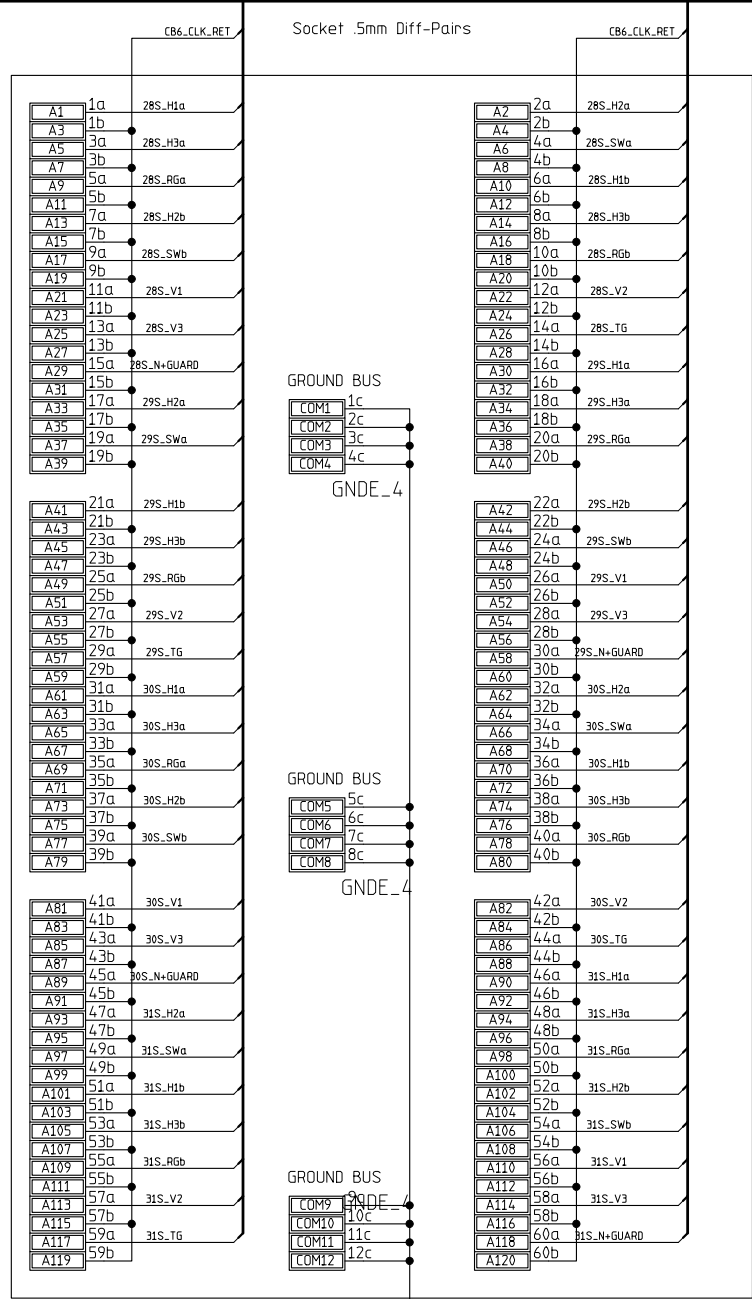
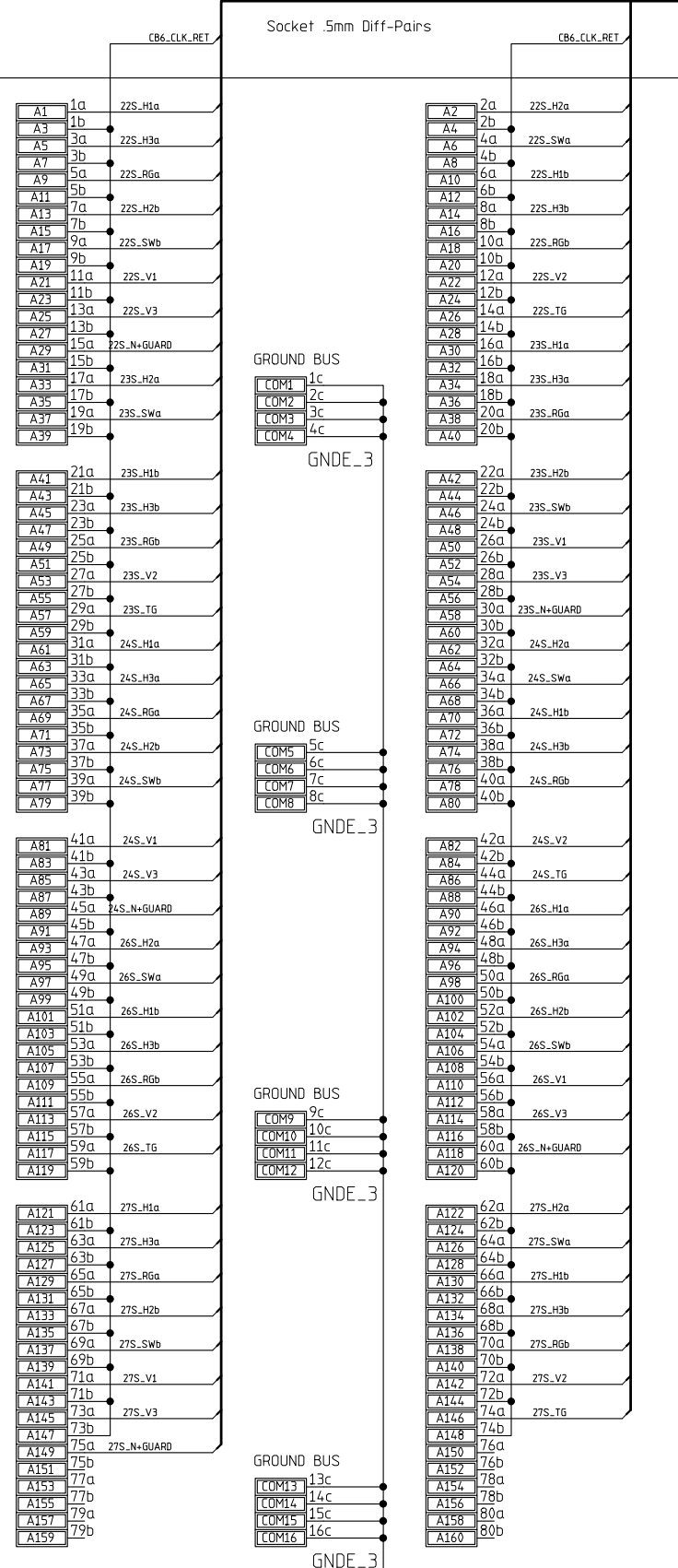

CLOCK SIGNALS

Clock Board: 6

CCDs: 22S 23S 24S 26S 27S
28S 29S 30S 31S

MODIFIED 2/24/2010 11:23:02 AM			
EED Department	ORIGINATOR	Walter Stuermer	DATE 10/26/2009
	DRAWN	drawn	DATE date
	CHECKED	checked	DATE date
	APPROVED	approved	DATE date
 Fermi National Accelerator Laboratory United States Department of Energy			
U:\CAD Projects\DES Cad Projects\PPD_JOBS\DES_FP5_VIB_B\DES_FP5_VIB_B.prj			
SIZE	DRAWING NUMBER	Schematic Page 02 of 27	REV
D	173694		A

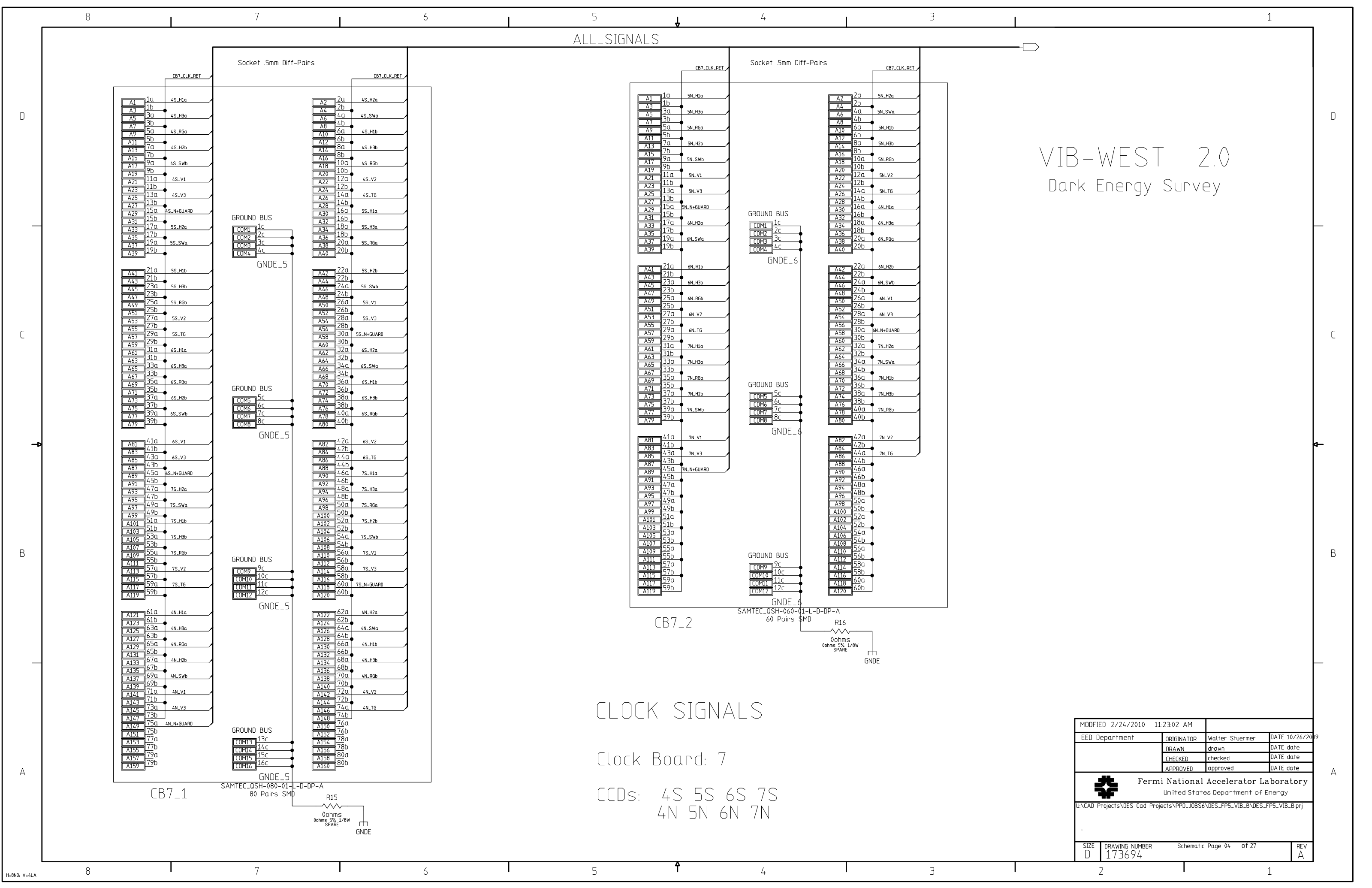

VIB-WEST 2.0
Dark Energy Survey

CLOCK SIGNALS

Clock Board: 7

CCDs: 4S 5S 6S 7S
4N 5N 6N 7N

MODIFIED 2/24/2010 11:23:02 AM			
EED Department	ORIGINATOR	Walter Stuermer	DATE 10/26/2009
	DRAWN	drawn	DATE date
	CHECKED	checked	DATE date
	APPROVED	approved	DATE date
 Fermi National Accelerator Laboratory United States Department of Energy			
U:\CAD Projects\DES Cad Projects\PPD_JOBS6\DES_FP5_VIB_B\DES_FP5_VIB_B.prj			
SIZE D	DRAWING NUMBER 173694	Schematic Page 04 of 27	REV A

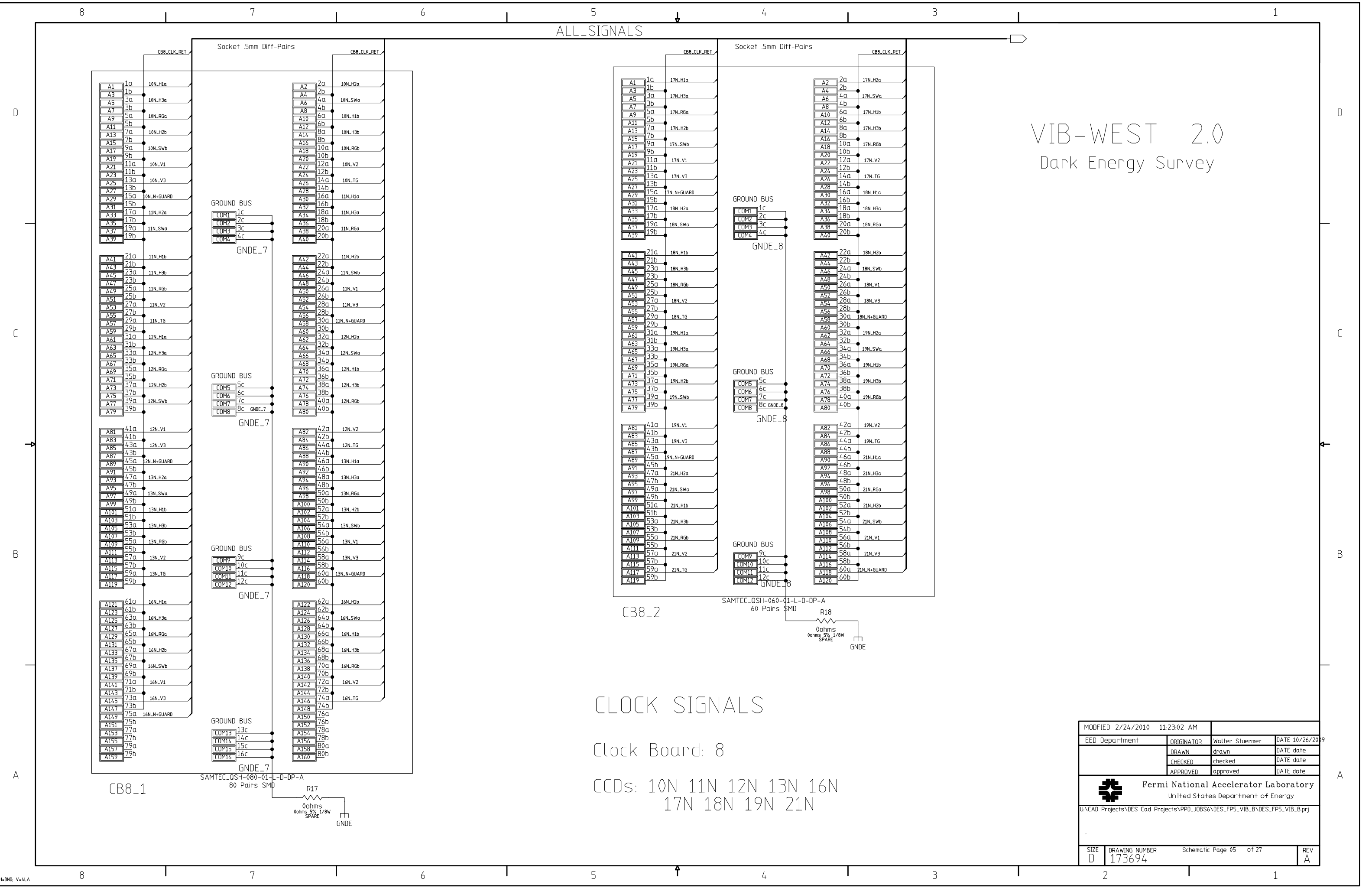

VIB-WEST 2.0
Dark Energy Survey

CLOCK SIGNALS

Clock Board: 8

CCDs: 10N 11N 12N 13N 16N
17N 18N 19N 21N

MODIFIED 2/24/2010 11:23:02 AM			
EED Department	ORIGINATOR	Walter Stuermer	DATE 10/26/2009
	DRAWN	drawn	DATE date
	CHECKED	checked	DATE date
	APPROVED	approved	DATE date
 Fermi National Accelerator Laboratory United States Department of Energy			
U:\CAD Projects\DES Cad Projects\PPD_JOBS6\DES_FP5_VIB_B\DES_FP5_VIB_B.pj			
SIZE	DRAWING NUMBER	Schematic Page 05 of 27	REV
D	173694		A

ALL_SIGNALS

VIB-WEST 2.0 Dark Energy Survey

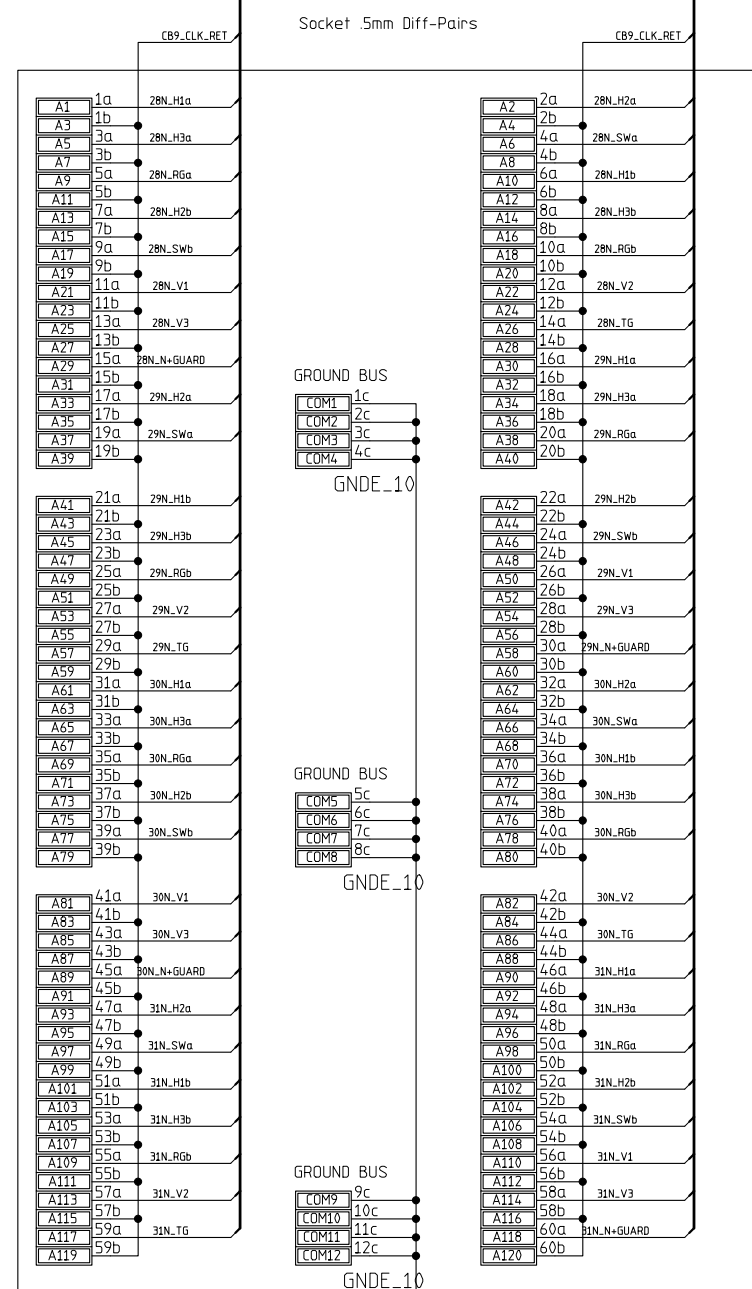
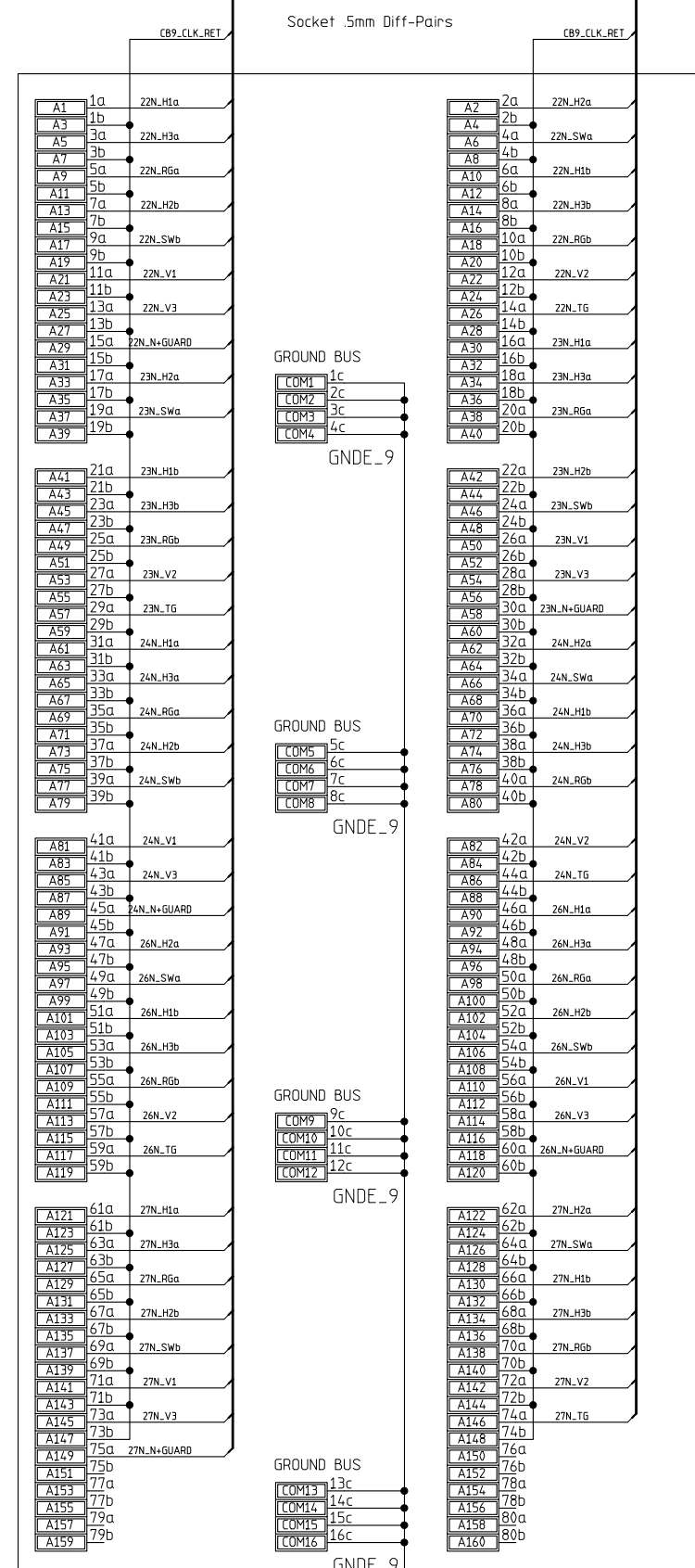

CLOCK SIGNALS

Clock Board 9

CCDs: 22N 23N 24N 26N 27N
28N 29N 30N 31N

MODIFIED 2/24/2010 11:23:02 AM			
EED Department	ORIGINATOR	Walter Stuermer	DATE 10/26/2009
	DRAWN	drawn	DATE date
	CHECKED	checked	DATE date
	APPROVED	approved	DATE date
 Fermi National Accelerator Laboratory United States Department of Energy			
U:\CAD Projects\DES Cad Projects\PPD_JOBS\DES_FP5_VIB_B\DES_FP5_VIB_B.prj			
SIZE D	DRAWING NUMBER 173694	Schematic Page 06 of 27	REV A

VIB-WEST 2.0 Dark Energy Survey

ALL_SIGNALS

Socket .5mm Diff-Pairs

Socket .5mm Diff-Pairs

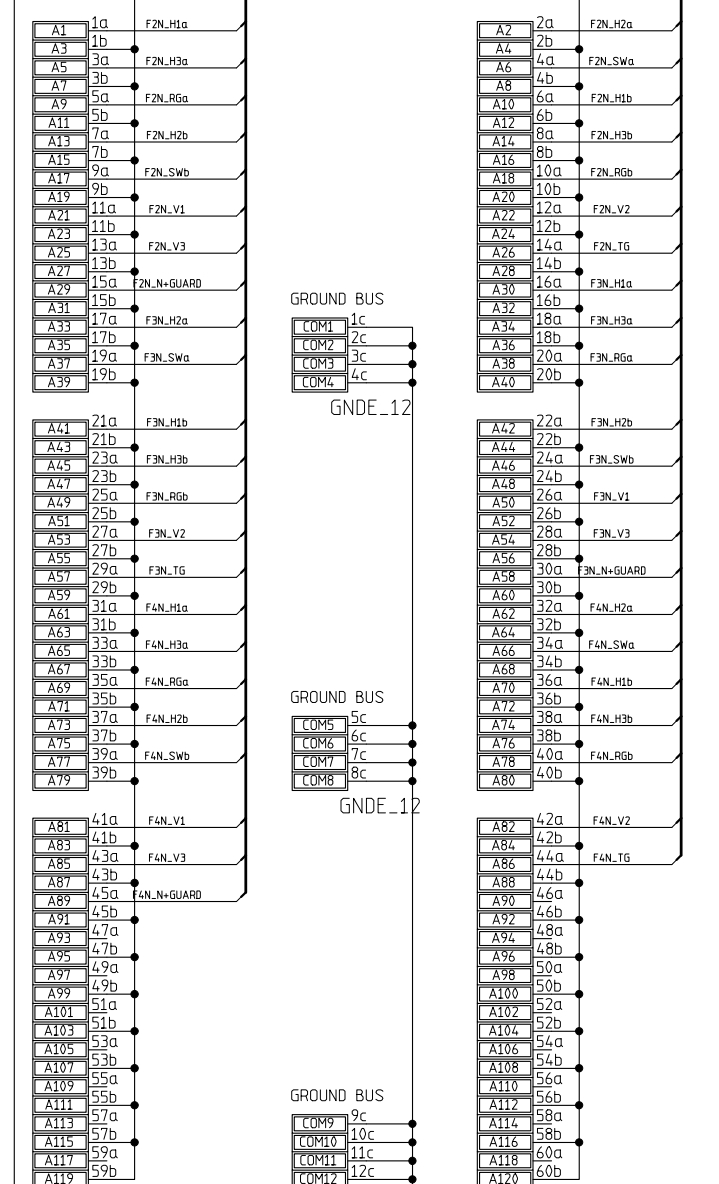
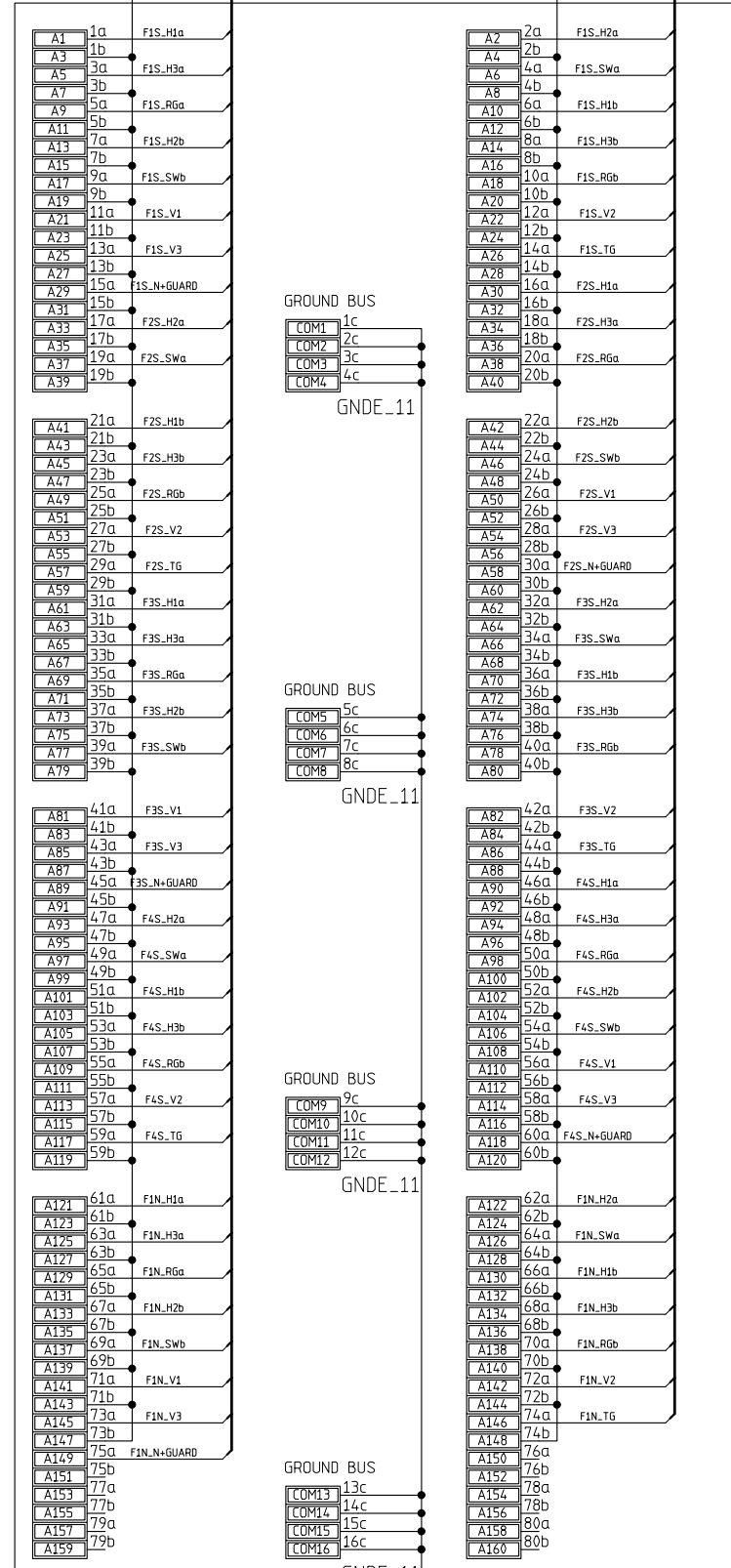

CLOCK SIGNALS

Clock Board: 10

CCDs: F1S F2S F3S F4S
F1N F2N F3N F4N

SAMTEC_QSH-080-01-L-D-DP-A
80 Pairs SMD

SAMTEC_QSH-060-01-L-D-DP-A
60 Pairs SMD

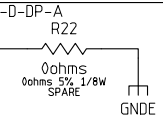
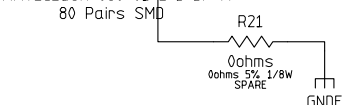

MODIFIED 2/24/2010 11:23:02 AM			
EED Department	ORIGINATOR	Walter Stuermer	DATE 10/26/2009
	DRAWN	drawn	DATE date
	CHECKED	checked	DATE date
	APPROVED	approved	DATE date
Fermi National Accelerator Laboratory United States Department of Energy			
U:\CAD Projects\DES Cad Projects\PPP06\DES_FP5_VIB_B\DES_FP5_VIB_B.prj			
SIZE	DRAWING NUMBER	Schematic Page 07 of 27	REV
D	173694		A

VIB-WEST 2.0 Dark Energy Survey

ALL SIGNALS

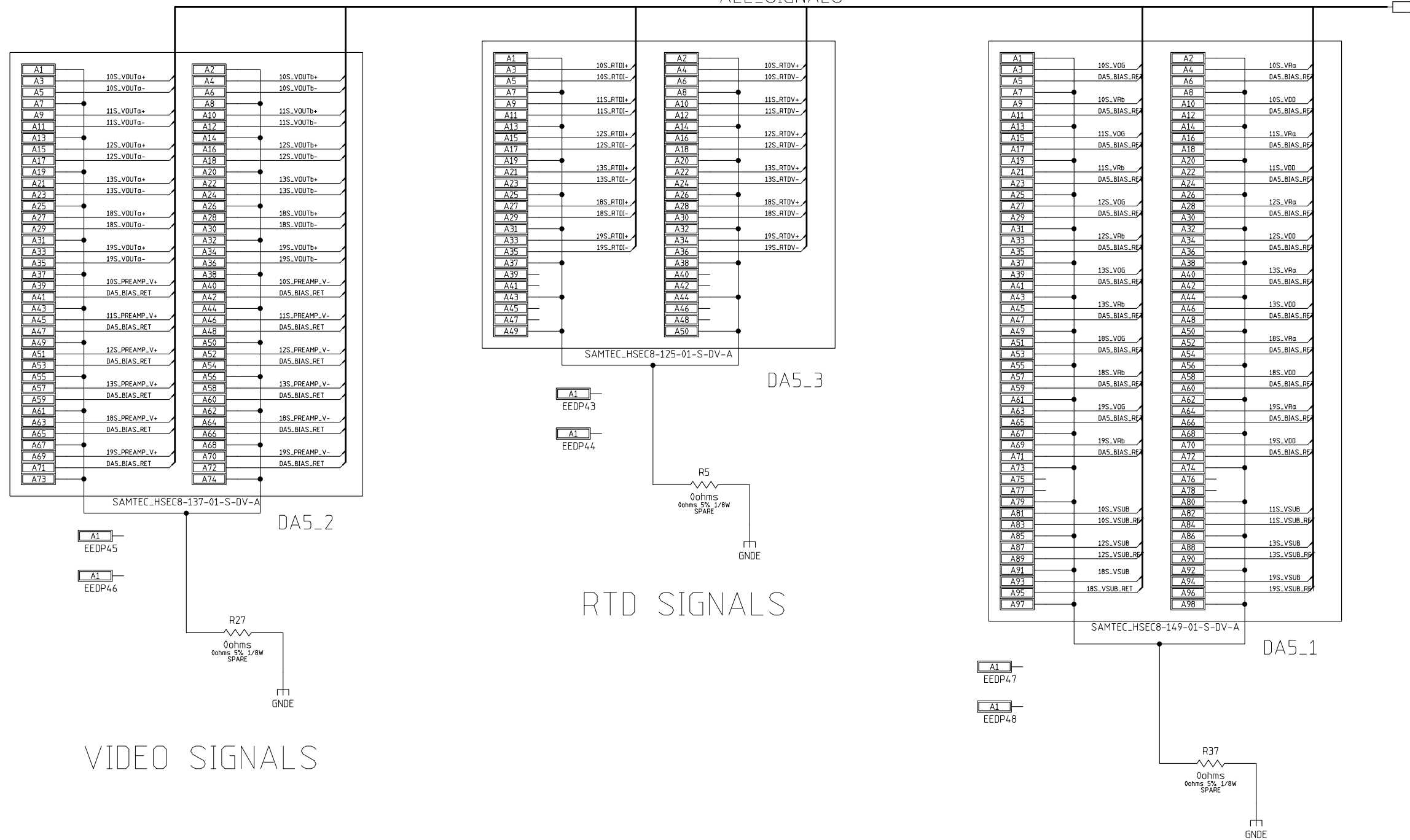

RTD SIGNALS

BIAS SIGNALS

VIDEO SIGNALS

Data Acquisition Board: 5
 CCDs: 10S 11S 12S 13S
 18S 19S

MODIFIED 2/24/2010 11:23:02 AM			
EED Department	ORIGINATOR	Walter Stuermer	DATE 10/26/2009
	DRAWN	drawn	DATE date
	CHECKED	checked	DATE date
	APPROVED	approved	DATE date
 Fermi National Accelerator Laboratory United States Department of Energy			
U:\CAD Projects\DES Cad Projects\PPD_JOBS6\DES_FP5_VIB_B\DES_FP5_VIB_B.pj			
SIZE D	DRAWING NUMBER 173694	Schematic Page 08 of 27	REV A

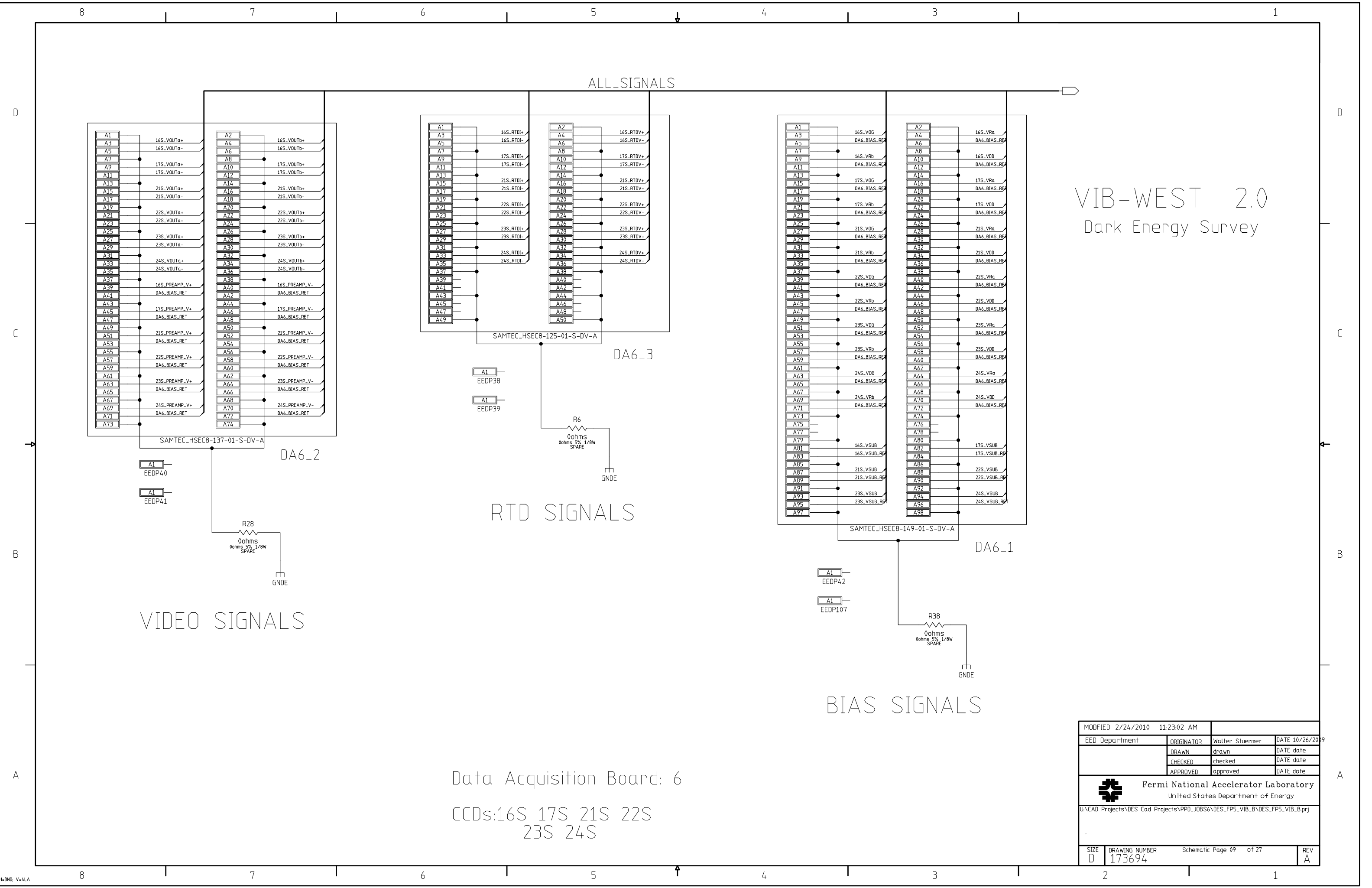

VIB-WEST 2.0
Dark Energy Survey

Data Acquisition Board: 6
CCDs: 16S 17S 21S 22S
23S 24S

MODIFIED 2/24/2010 11:23:02 AM			
EED Department	ORIGINATOR	Walter Stuermer	DATE 10/26/2009
	DRAWN	drawn	DATE date
	CHECKED	checked	DATE date
	APPROVED	approved	DATE date
 Fermi National Accelerator Laboratory United States Department of Energy			
U:\CAD Projects\DES Cad Projects\PPD_JOBS\DES_FP5_VIB_B\DES_FP5_VIB_B.prj			
SIZE D	DRAWING NUMBER 173694	Schematic Page 09 of 27	REV A

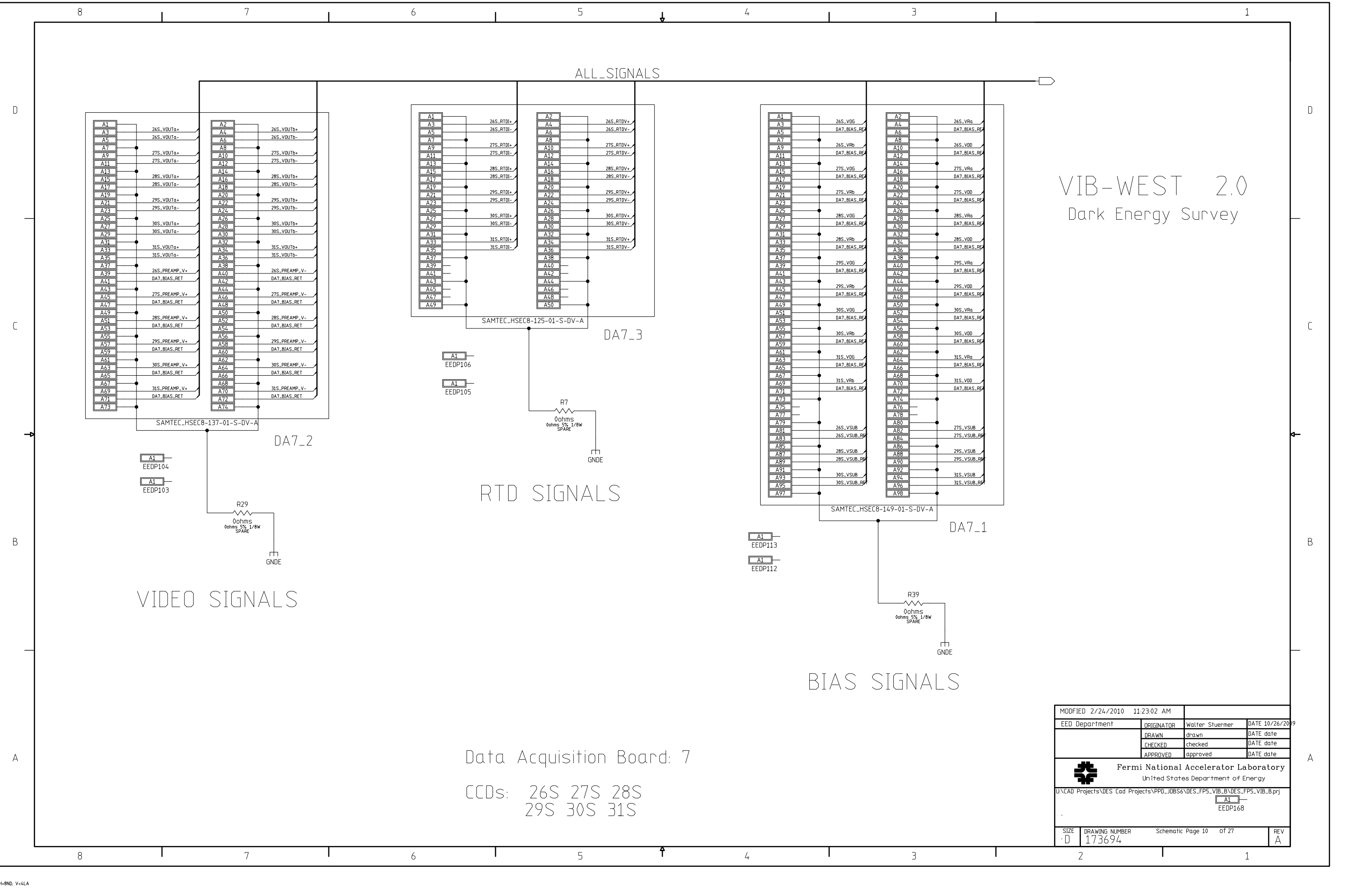

VIB-WEST 2.0
Dark Energy Survey

Data Acquisition Board: 7
 CCDs: 26S 27S 28S
 29S 30S 31S

MODIFIED 2/24/2010 11:23:02 AM			
EED Department	ORIGINATOR	Walter Stuermer	DATE 10/26/2009
	DRAWN	drawn	DATE date
	CHECKED	checked	DATE date
	APPROVED	approved	DATE date
 Fermi National Accelerator Laboratory United States Department of Energy			
U:\CAD Projects\DES Cad Projects\PPD_JOBS6\DES_FP5_VIB_B\DES_FP5_VIB_B.prj <div style="text-align: right;"> EEDP168 </div>			
SIZE	DRAWING NUMBER	Schematic Page 10 of 27	REV
D	173694		A

VIB-WEST 2.0 Dark Energy Survey

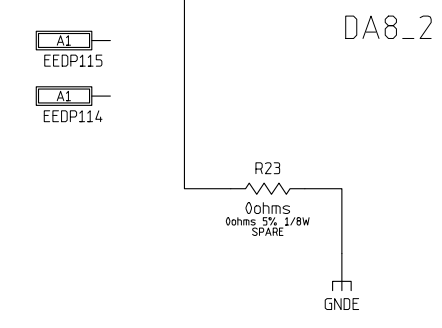
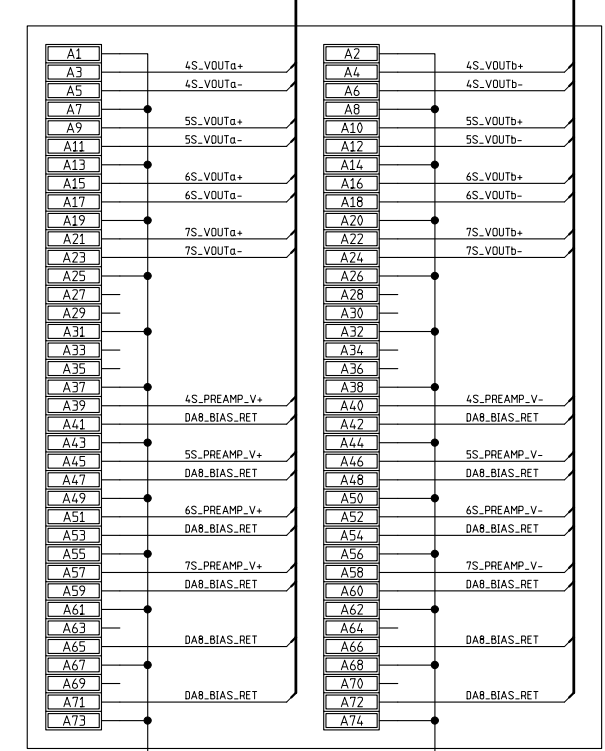

VIDEO SIGNALS

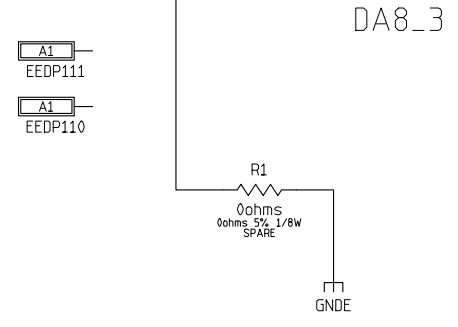
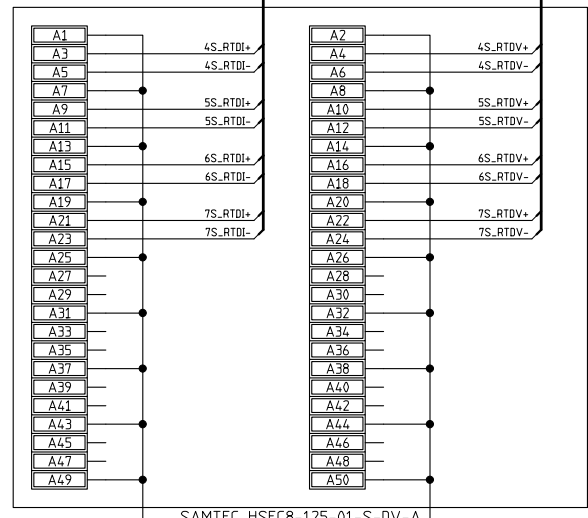

RTD SIGNALS

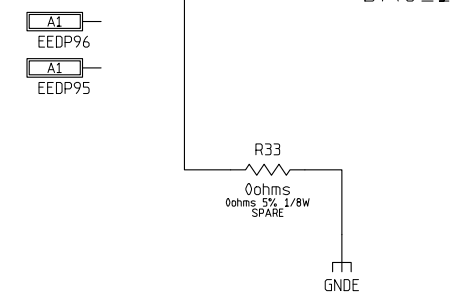
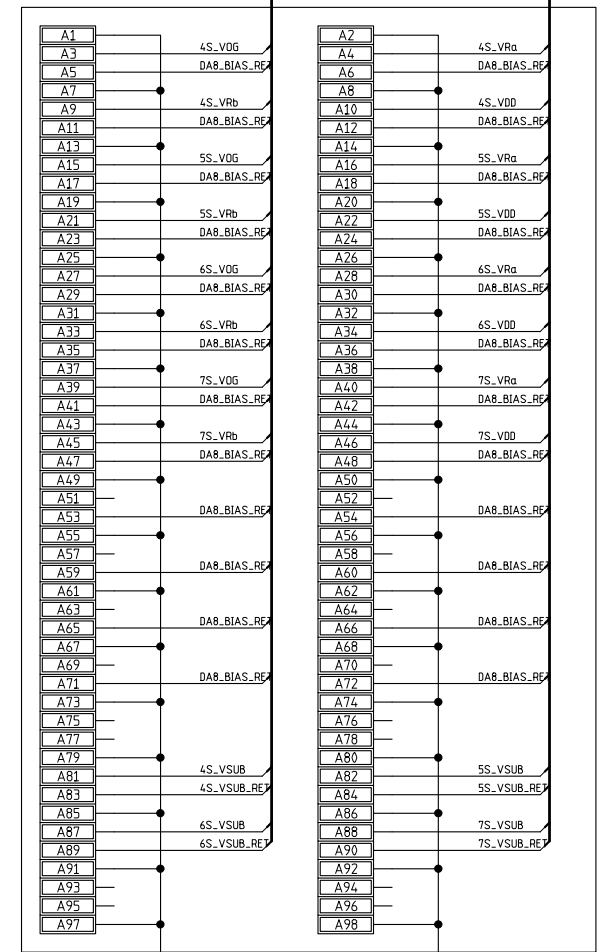

BIAS SIGNALS

Data Acquisition Board: 8
CCDs: 4S 5S 6S 7S

MODIFIED 2/24/2010 11:23:02 AM			
EED Department	ORIGINATOR	Walter Stuermer	DATE 10/26/2009
	DRAWN	drawn	DATE date
	CHECKED	checked	DATE date
	APPROVED	approved	DATE date
 Fermi National Accelerator Laboratory United States Department of Energy			
U:\CAD Projects\DES Cad Projects\PPD_JOBS6\DES_FP5_VIB.B\DES_FP5_VIB_B.prj			
SIZE D	DRAWING NUMBER 173694	Schematic Page 11 of 27	REV A

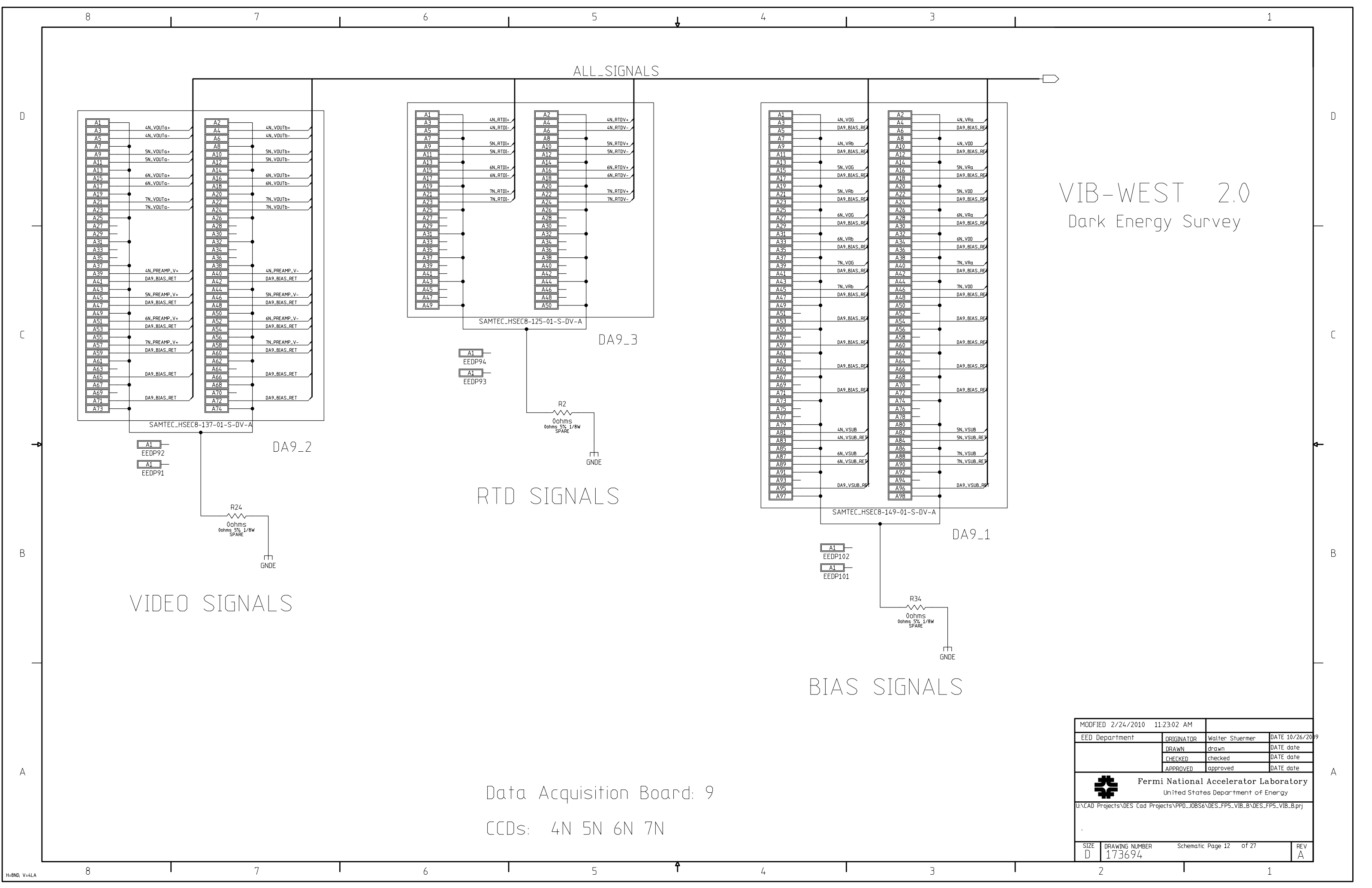

VIB-WEST 2.0
Dark Energy Survey

Data Acquisition Board: 9
CCDs: 4N 5N 6N 7N

MODIFIED 2/24/2010 11:23:02 AM			
EED Department	ORIGINATOR	Walter Stuermer	DATE 10/26/2009
	DRAWN	drawn	DATE date
	CHECKED	checked	DATE date
	APPROVED	approved	DATE date
 Fermi National Accelerator Laboratory United States Department of Energy			
U:\CAD Projects\DES Cad Projects\PPD_JOBS6\DES_FP5_VIB.B\DES_FP5_VIB.B.prj			
SIZE D	DRAWING NUMBER 173694	Schematic Page 12 of 27	REV A

VIB-WEST 2.0 Dark Energy Survey

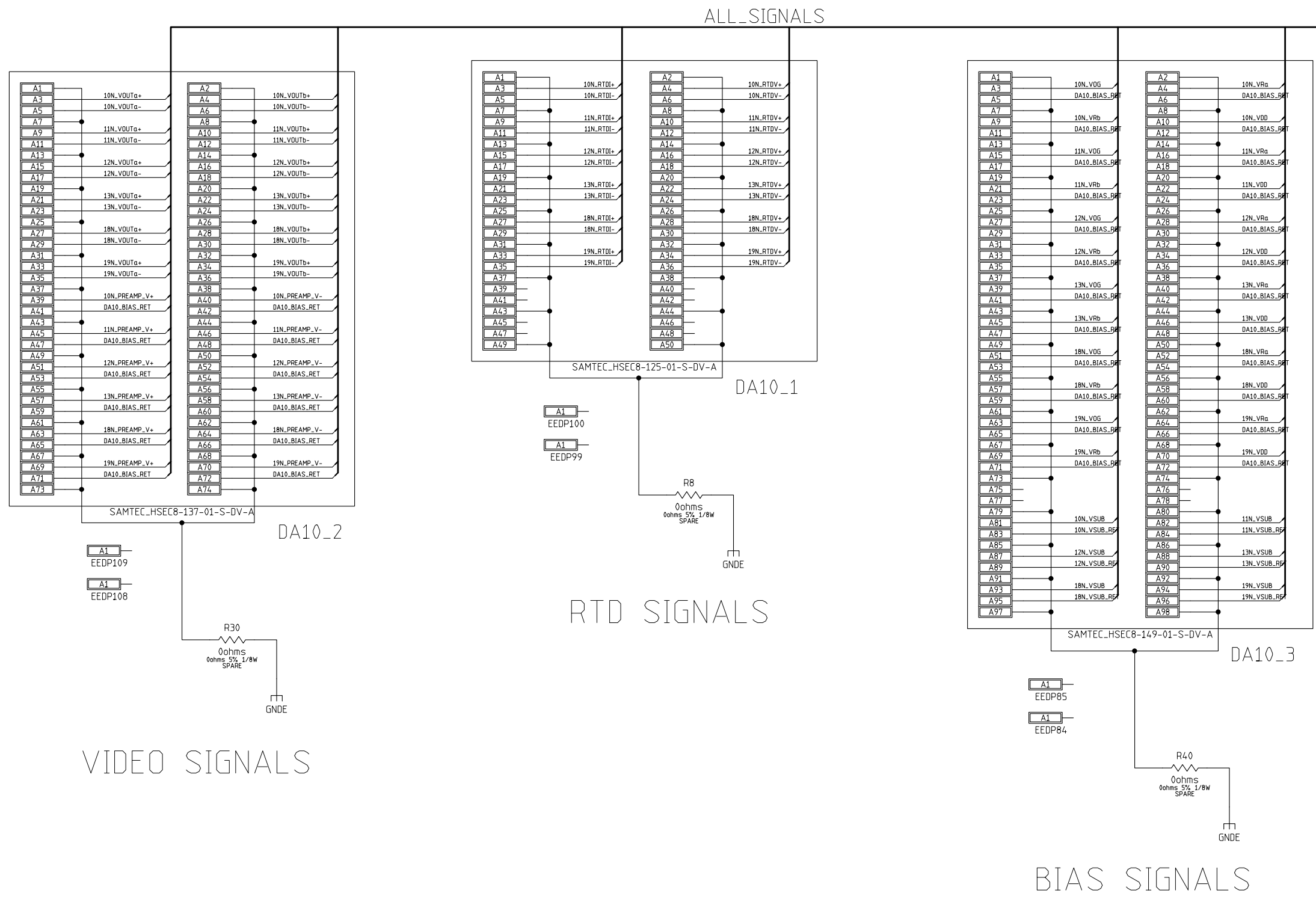

Data Acquisition Board: 10
 CCDs: 10N 11N 12N 13N
 18N 19N

MODIFIED 2/24/2010 11:23:02 AM			
EED Department	ORIGINATOR	Walter Stuermer	DATE 10/26/2009
	DRAWN	drawn	DATE date
	CHECKED	checked	DATE date
	APPROVED	approved	DATE date
 Fermi National Accelerator Laboratory United States Department of Energy			
U:\CAD Projects\DES Cad Projects\PPD_JOBS6\DES_FP5_VIB.B\DES_FP5_VIB_B.prj			
SIZE	DRAWING NUMBER	Schematic Page 13 of 27	REV
D	173694		A

VIB-WEST 2.0 Dark Energy Survey

ALL SIGNALS

RTD SIGNALS

BIAS SIGNALS

VIDEO SIGNALS

Data Acquisition Board: 11
 CCDs: 16N 17N 21N
 22N 23N 24N

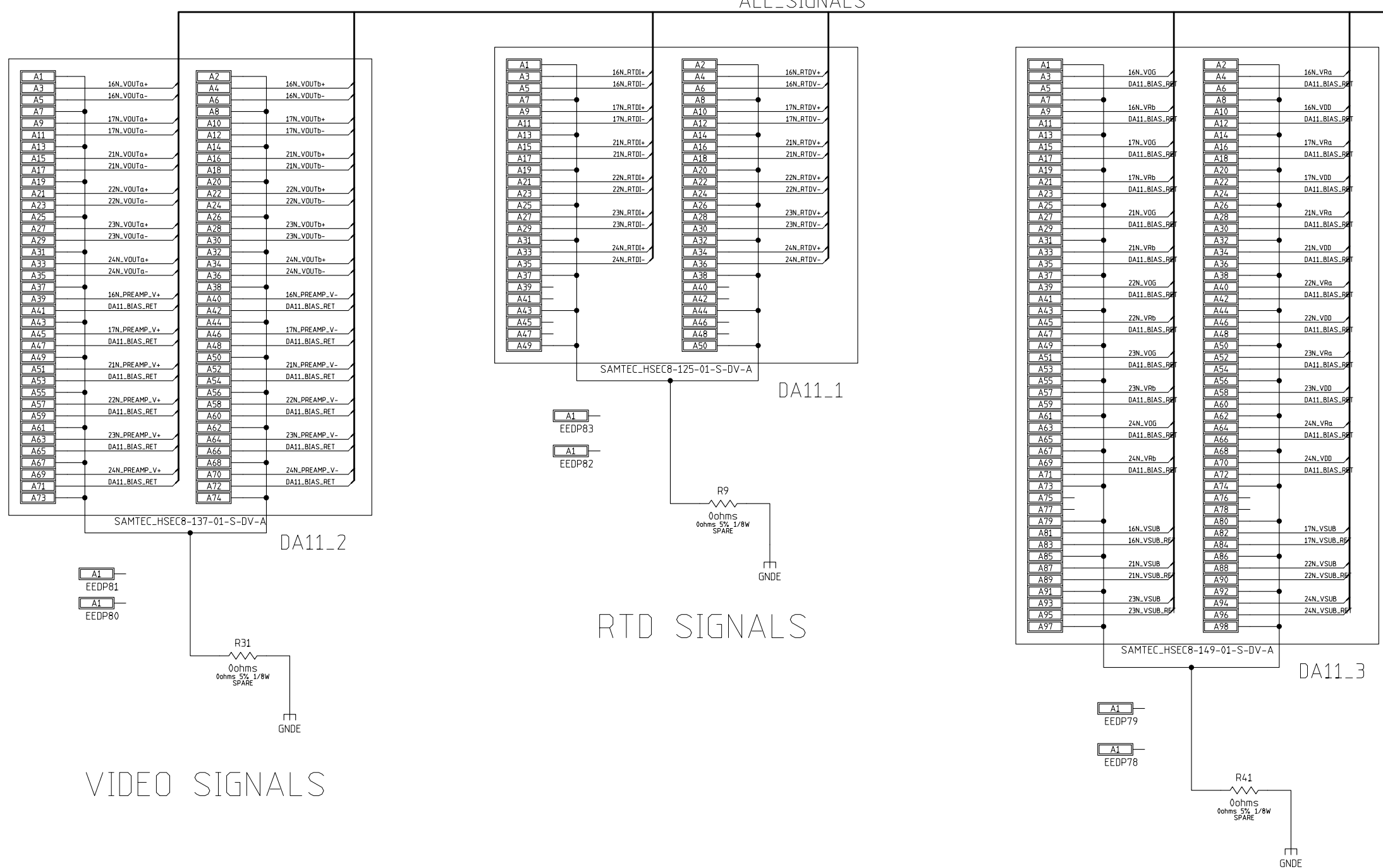

MODIFIED 2/24/2010 11:23:02 AM			
EED Department	ORIGINATOR	Walter Stuermer	DATE 10/26/2009
	DRAWN	drawn	DATE date
	CHECKED	checked	DATE date
	APPROVED	approved	DATE date
 Fermi National Accelerator Laboratory United States Department of Energy			
U:\CAD Projects\DES Cad Projects\PPD_JOBS6\DES_FP5_VIB_B\DES_FP5_VIB_B.prj			
SIZE D	DRAWING NUMBER 173694	Schematic Page 14 of 27	REV A

VIB-WEST 2.0 Dark Energy Survey

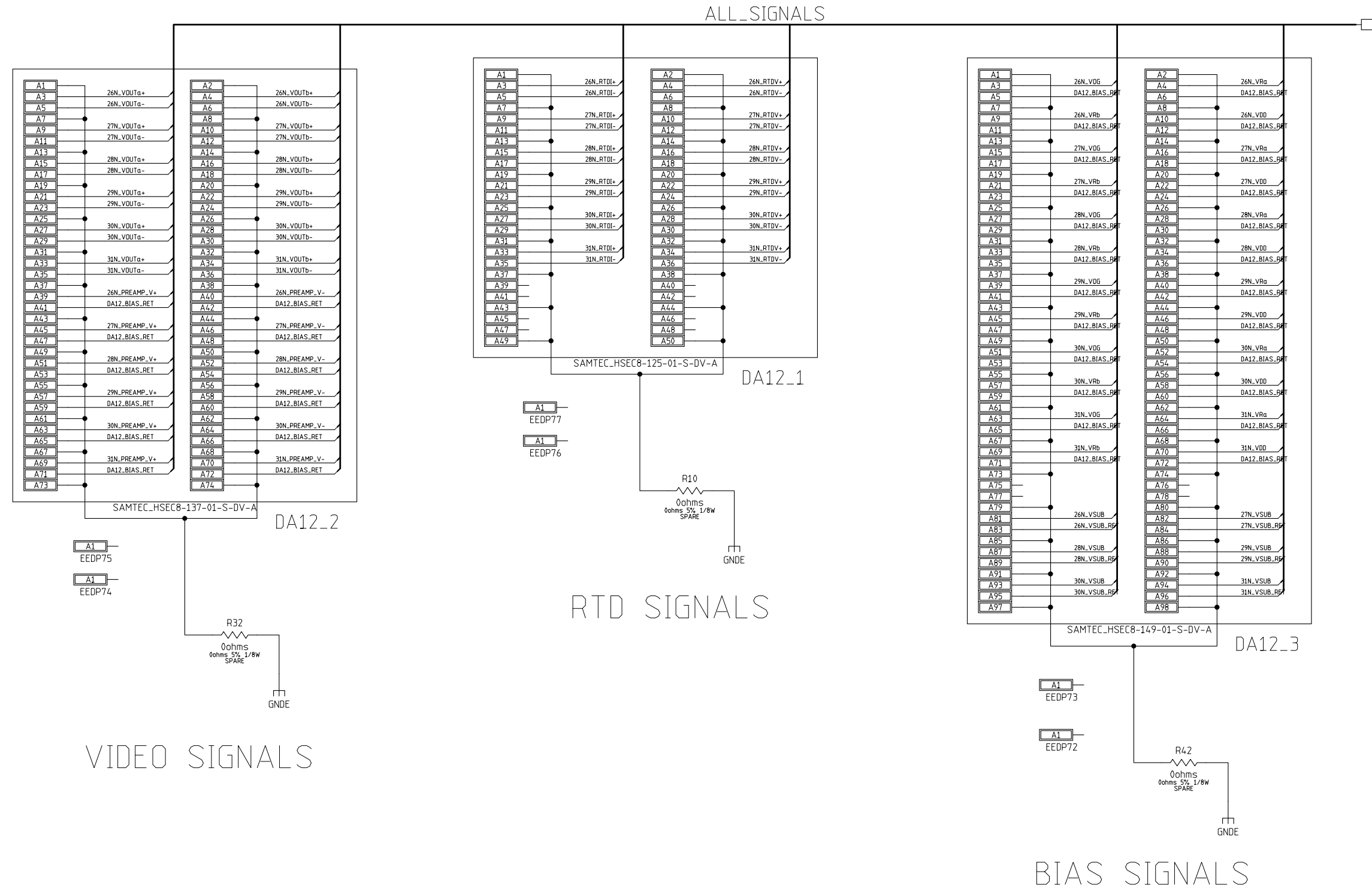

Data Acquisition Board: 12

CCDs: 26N 27N 28N
29N 30N 31N

MODIFIED 2/24/2010 11:23:02 AM			
EED Department	ORIGINATOR	Walter Stuermer	DATE 10/26/2009
	DRAWN	drawn	DATE date
	CHECKED	checked	DATE date
	APPROVED	approved	DATE date
 Fermi National Accelerator Laboratory United States Department of Energy			
U:\CAD Projects\DES Cad Projects\PPD_JOBS6\DES_FP5_VIB.B\DES_FP5_VIB_B.prj			
SIZE D	DRAWING NUMBER 173694	Schematic Page 15 of 27	REV A

VIB-WEST 2.0 Dark Energy Survey

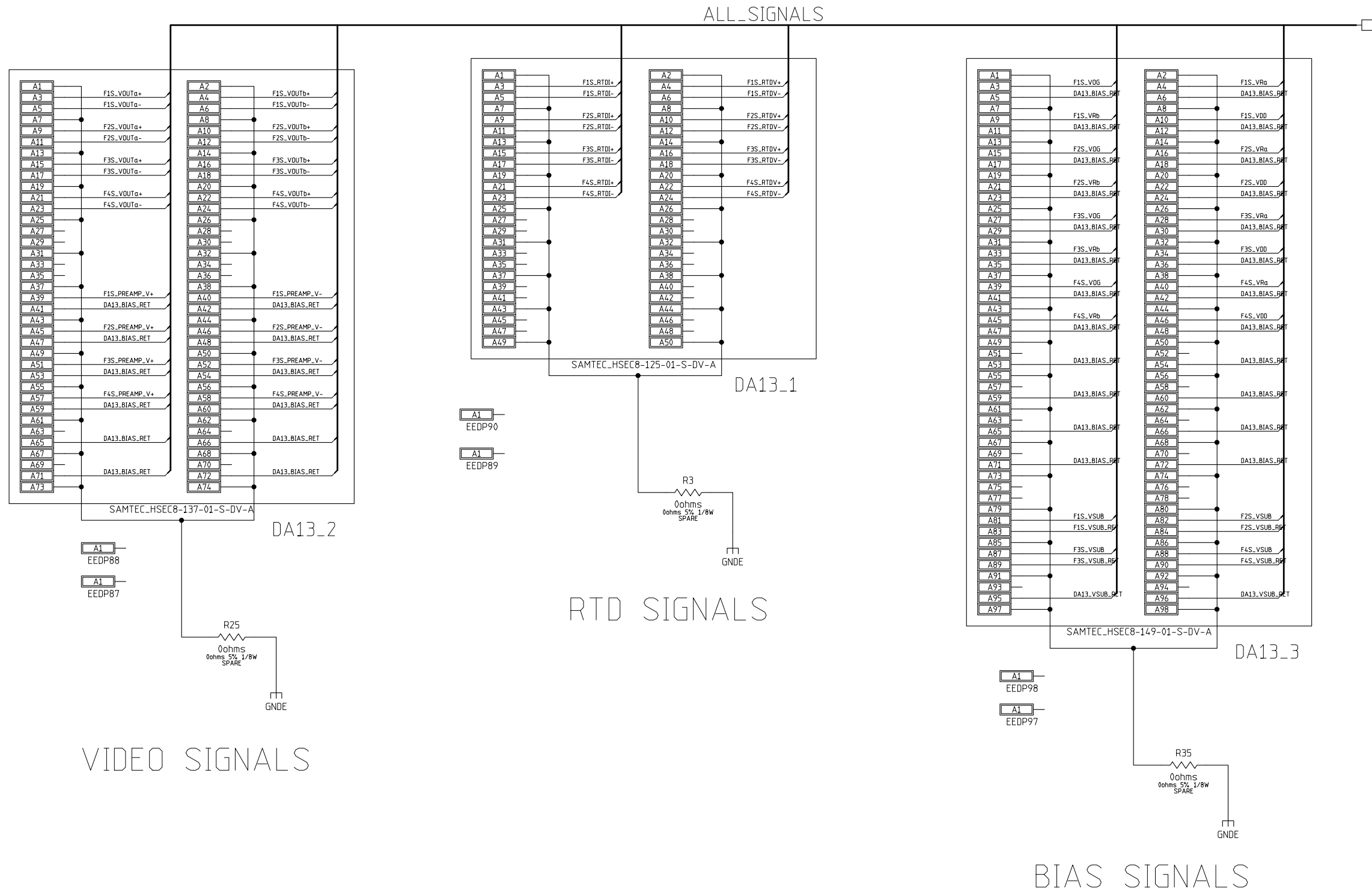

Data Acquisition Board: 13
CCDs: F1S F2S F3S F4S

MODIFIED 2/24/2010 11:23:02 AM			
EED Department	ORIGINATOR	Walter Stuermer	DATE 10/26/2009
	DRAWN	drawn	DATE date
	CHECKED	checked	DATE date
	APPROVED	approved	DATE date
 Fermi National Accelerator Laboratory United States Department of Energy			
U:\CAD Projects\DES Cad Projects\PPP0_JOBS6\DES_FP5_VIB.B\DES_FP5_VIB_B.prj			
SIZE D	DRAWING NUMBER 173694	Schematic Page 16 of 27	REV A

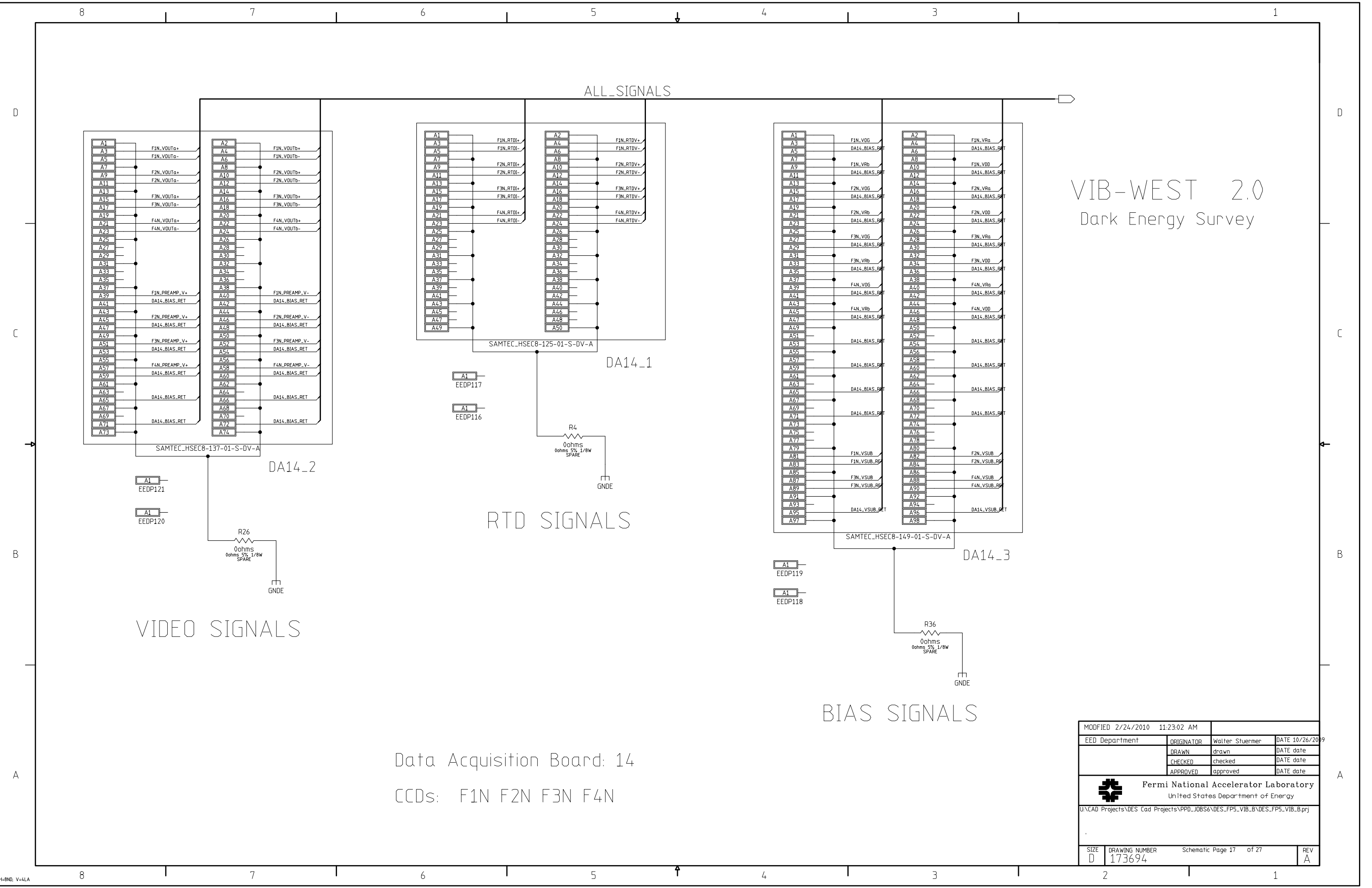

VIB-WEST 2.0
Dark Energy Survey

Data Acquisition Board: 14
CCDs: F1N F2N F3N F4N

MODIFIED 2/24/2010 11:23:02 AM			
EED Department	ORIGINATOR	Walter Stuermer	DATE 10/26/2009
	DRAWN	drawn	DATE date
	CHECKED	checked	DATE date
	APPROVED	approved	DATE date
 Fermi National Accelerator Laboratory United States Department of Energy			
U:\CAD Projects\DES Cad Projects\PPD_JOBS6\DES_FP5_VIB.B\DES_FP5_VIB.B.prj			
SIZE D	DRAWING NUMBER 173694	Schematic Page 17 of 27	REV A

VIB-WEST 2.0

Dark Energy Survey

ALL_SIGNALS

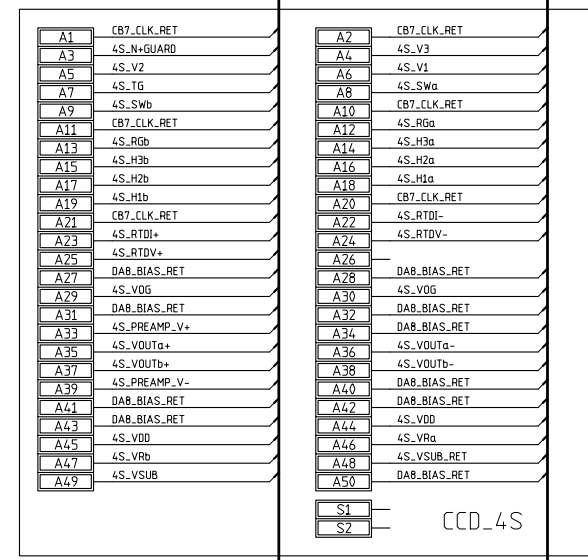

CCD 4S
CB 7 DA 8
AMP 104550-6

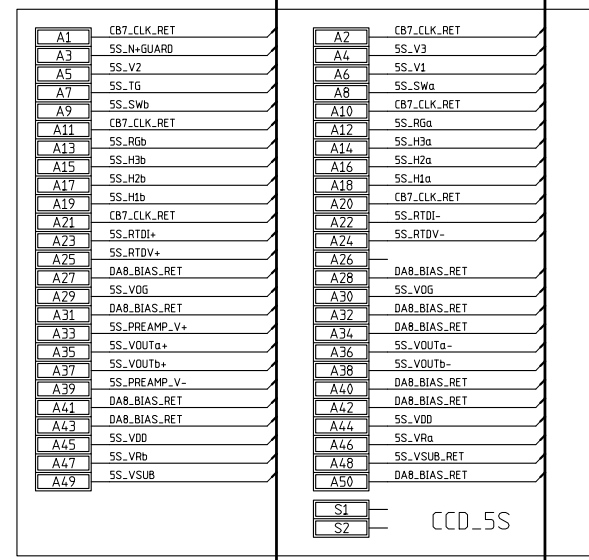

CCD 5S
CB 7 DA 8
AMP 104550-6

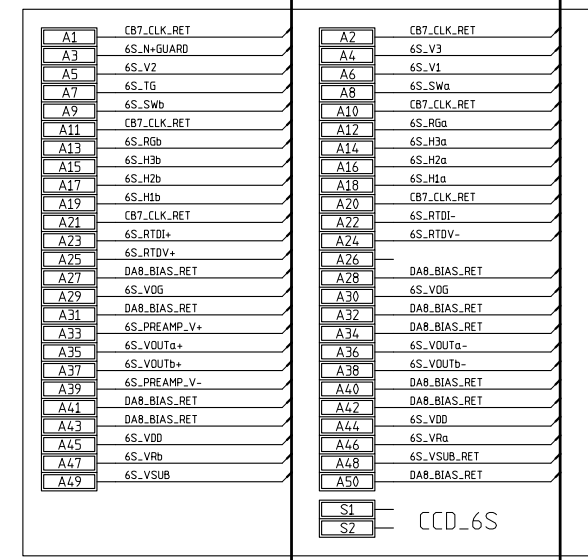

CCD 6S
CB 7 DA 8
AMP 104550-6

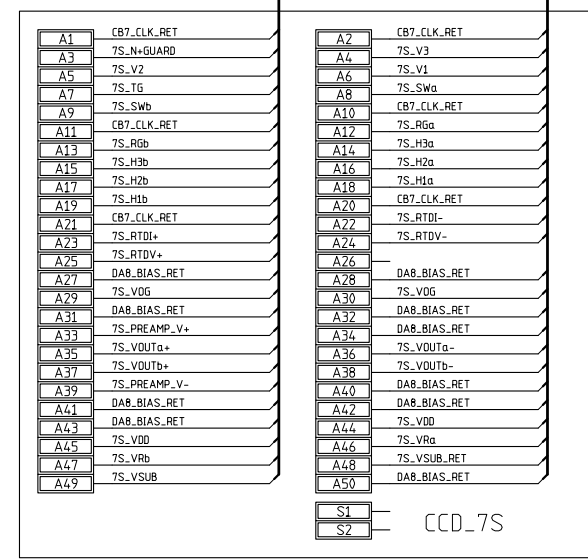

CCD 7S
CB 7 DA 8
AMP 104550-6

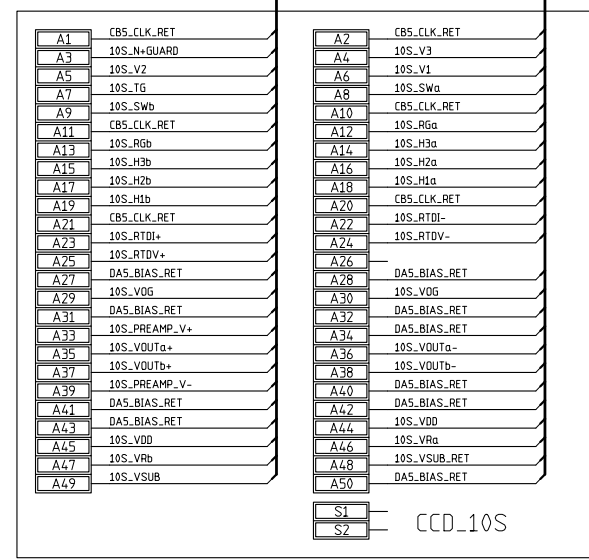

CCD 10S
CB 5 DA 5
AMP 104550-6

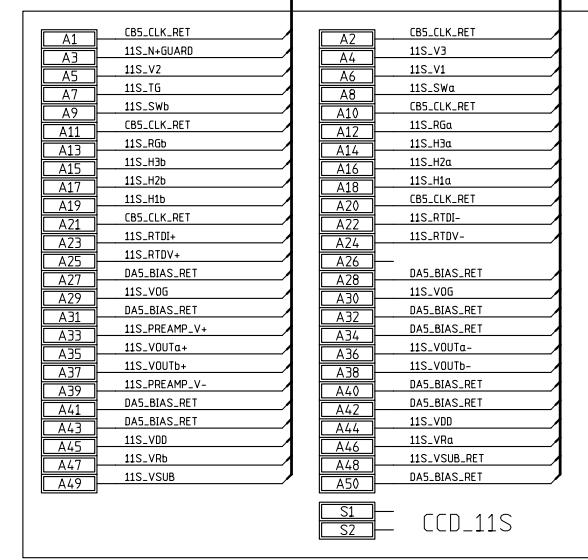

CCD 11S
CB 5 DA 5
AMP 104550-6

VIB-INTERFACE CARDS

MODIFIED 2/24/2010 11:23:02 AM			
EED Department	ORIGINATOR	Walter Stuermer	DATE 10/26/2009
	DRAWN	drawn	DATE date
	CHECKED	checked	DATE date
	APPROVED	approved	DATE date
 Fermi National Accelerator Laboratory United States Department of Energy			
U:\CAD Projects\DES Cad Projects\PPP5_JOBS6\DES_FP5_VIB_B\DES_FP5_VIB_B.pj			
SIZE	DRAWING NUMBER	Schematic Page 18 of 27	REV
D	173694		A

VIB-WEST 2.0

Dark Energy Survey

ALL_SIGNALS

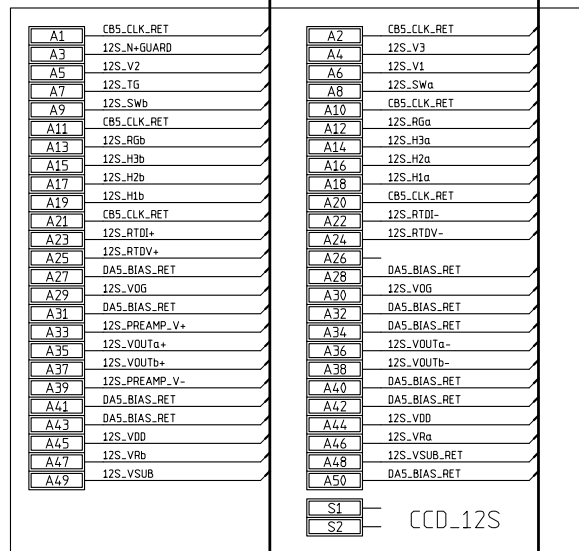

CCD 12S
CB 5 DA 5

AMP 104550-6

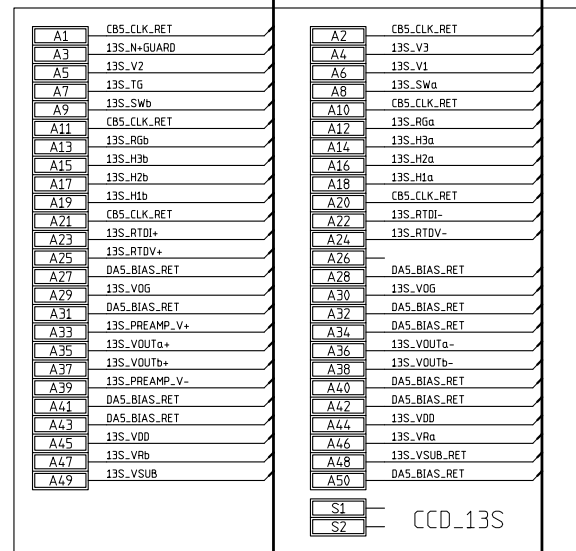

CCD 13S
CB 5 DA 5

AMP 104550-6

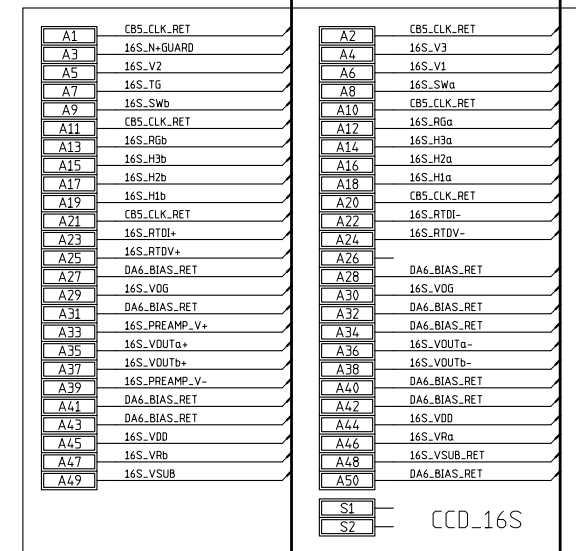

CCD 16S
CB 5 DA 6

AMP 104550-6

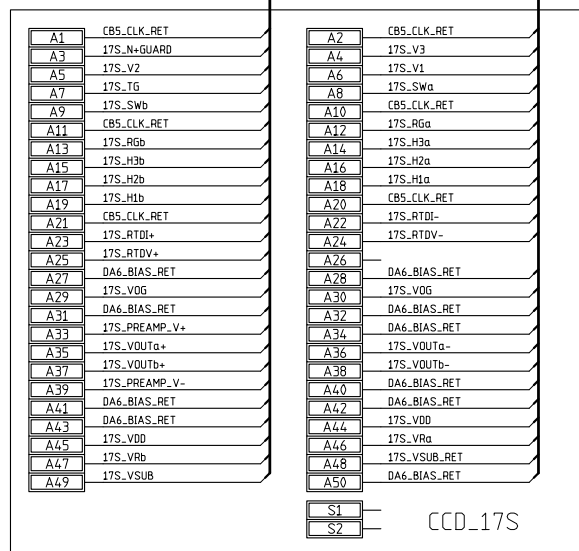

CCD 17S
CB 5 DA 6

AMP 104550-6

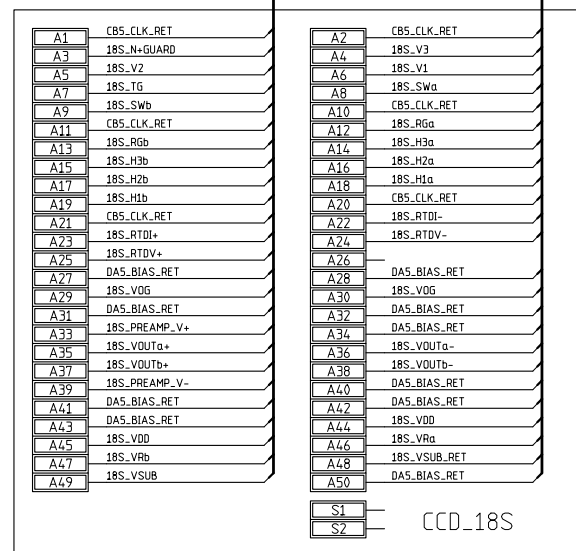

CCD 18S
CB 5 DA 5

AMP 104550-6

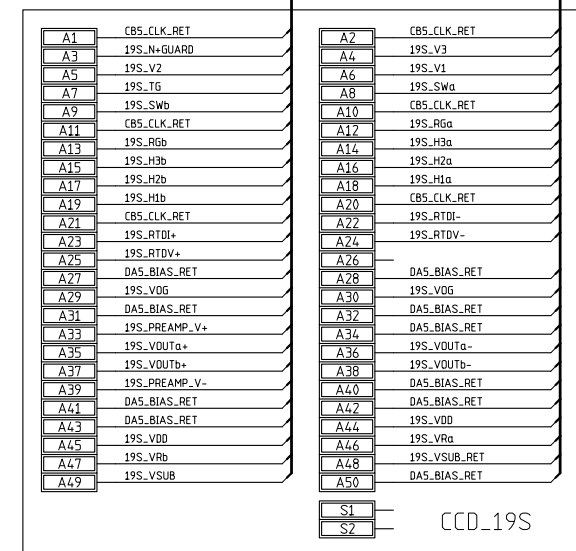

CCD 19S
CB 5 DA 5

AMP 104550-6

VIB-INTERFACE CARDS

MODIFIED 2/24/2010 11:23:02 AM			
EED Department	ORIGINATOR	Walter Stuermer	DATE 10/26/2009
	DRAWN	drawn	DATE date
	CHECKED	checked	DATE date
	APPROVED	approved	DATE date
 Fermi National Accelerator Laboratory United States Department of Energy			
U:\CAD Projects\DES Cad Projects\PPD5\DES_FP5_VIB.B\DES_FP5_VIB_B.pj			
SIZE	DRAWING NUMBER	Schematic Page 19 of 27	REV
D	173694		A

VIB-WEST 2.0 Dark Energy Survey

ALL_SIGNALS

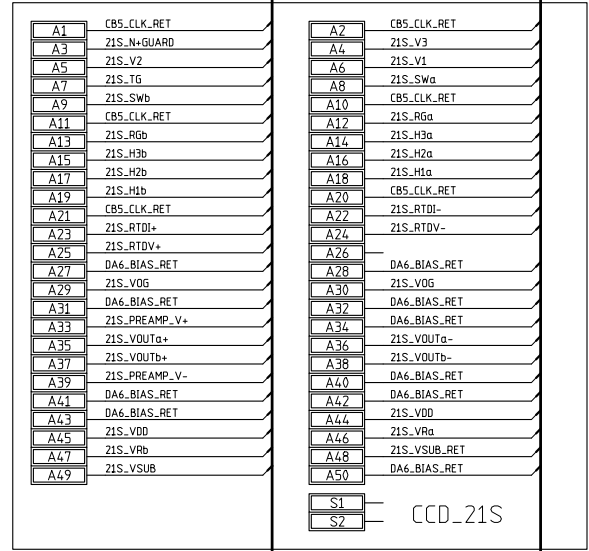

CCD 21S
CB 5 DA 6

AMP 104550-6

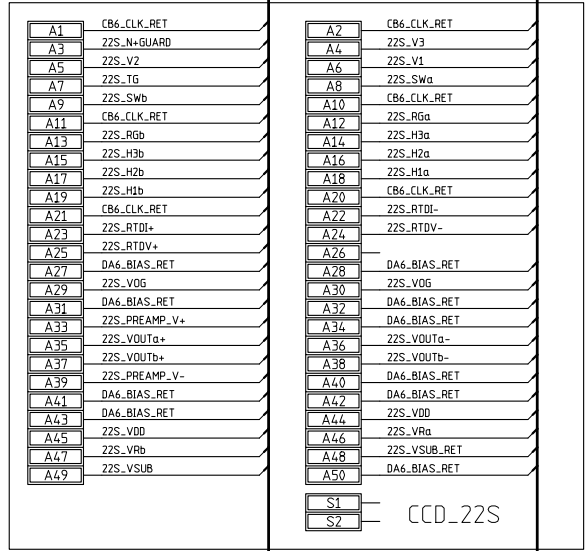

CCD 22S
CB 6 DA 6

AMP 104550-6

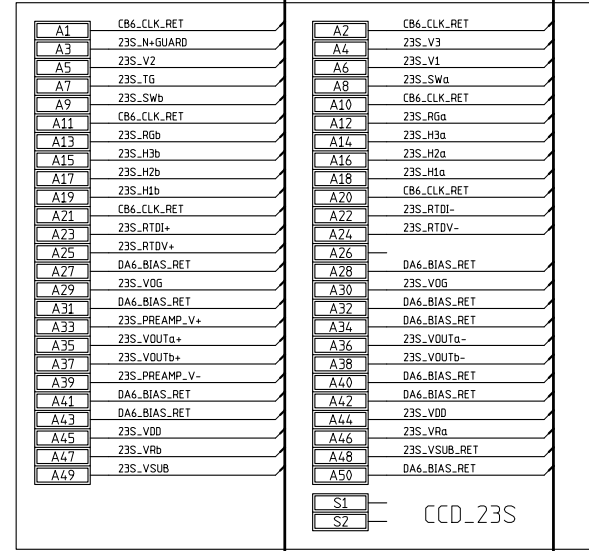

CCD 23S
CB 6 DA 6

AMP 104550-6

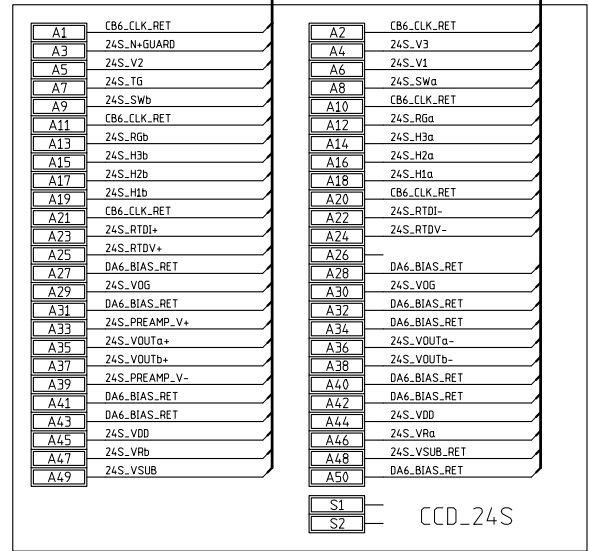

CCD 24S
CB 6 DA 6

AMP 104550-6

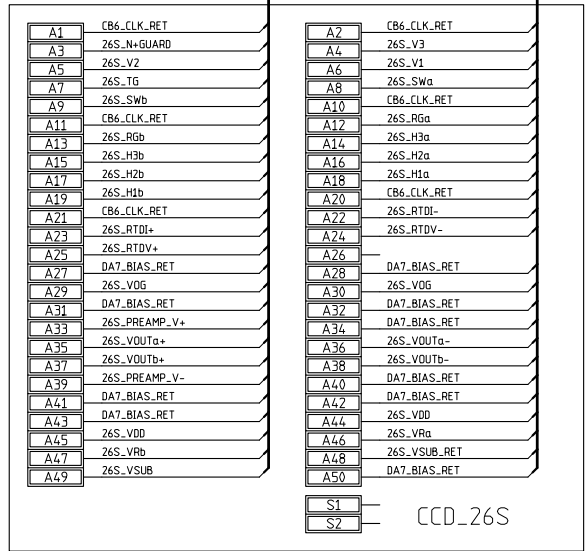

CCD 26S
CB 6 DA 7

AMP 104550-6

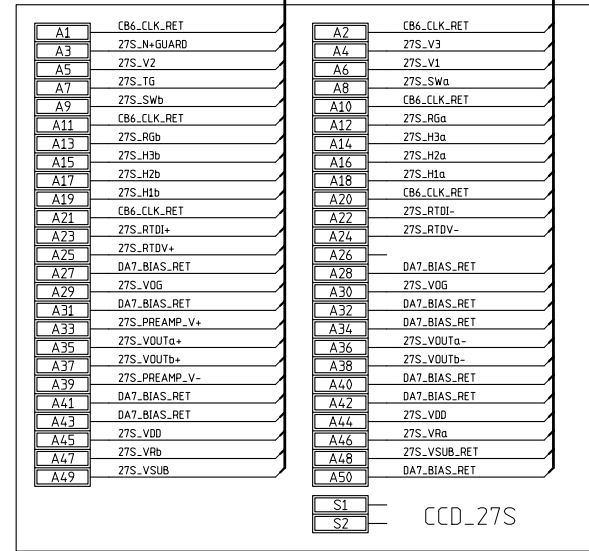

CCD 27S
CB 6 DA 7

AMP 104550-6

VIB-INTERFACE CARDS

MODIFIED 2/24/2010 11:23:02 AM			
EED Department	ORIGINATOR	Walter Stuermer	DATE 10/26/2009
	DRAWN	drawn	DATE date
	CHECKED	checked	DATE date
	APPROVED	approved	DATE date
 Fermi National Accelerator Laboratory United States Department of Energy			
U:\CAD Projects\DES Cad Projects\PPD_JOBS6\DES_FP5_VIB.B\DES_FP5_VIB_B.pj			
SIZE D	DRAWING NUMBER 173694	Schematic Page 20 of 27	REV A

H:\BND_V=4LA

VIB-WEST 2.0

Dark Energy Survey

ALL_SIGNALS

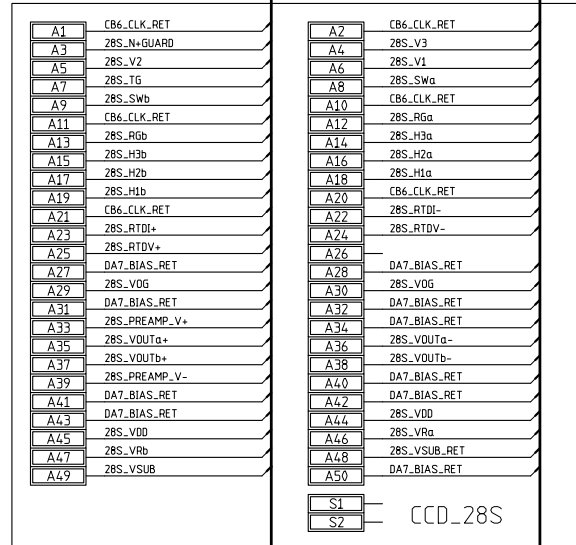

CCD 28S
CB 6 DA 7

AMP 104550-6

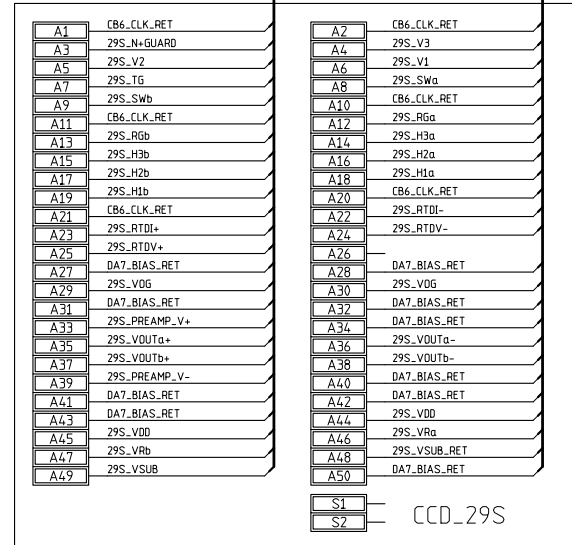

CCD 29S
CB 6 DA 7

AMP 104550-6

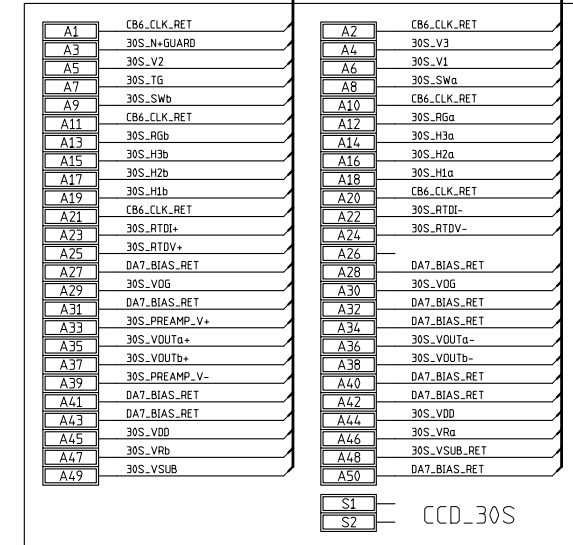

CCD 30S
CB 6 DA 7

AMP 104550-6

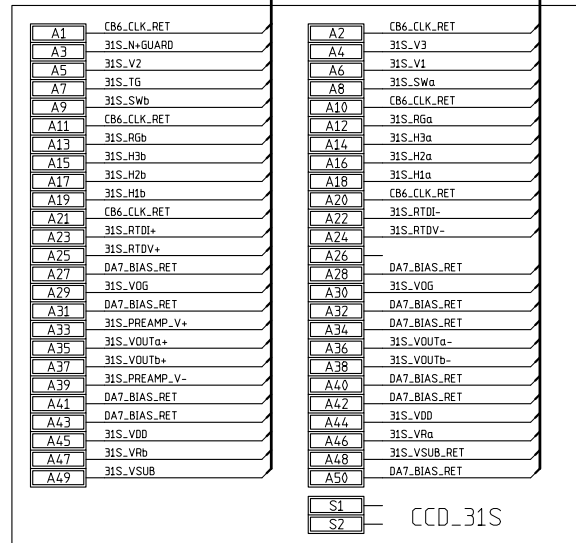

CCD 31S
CB 6 DA 7

AMP 104550-6

VIB-INTERFACE CARDS

MODIFIED 2/24/2010 11:23:02 AM			
EED Department	ORIGINATOR	Walter Stuermer	DATE 10/26/2009
	DRAWN	drawn	DATE date
	CHECKED	checked	DATE date
	APPROVED	approved	DATE date
 Fermi National Accelerator Laboratory United States Department of Energy			
U:\CAD Projects\DES Cad Projects\PPP06\DES_FP5_VIB.B\DES_FP5_VIB_B.prj			
SIZE	DRAWING NUMBER	Schematic Page 21 of 27	REV
D	173694		A

VIB-WEST 2.0

Dark Energy Survey

ALL_SIGNALS

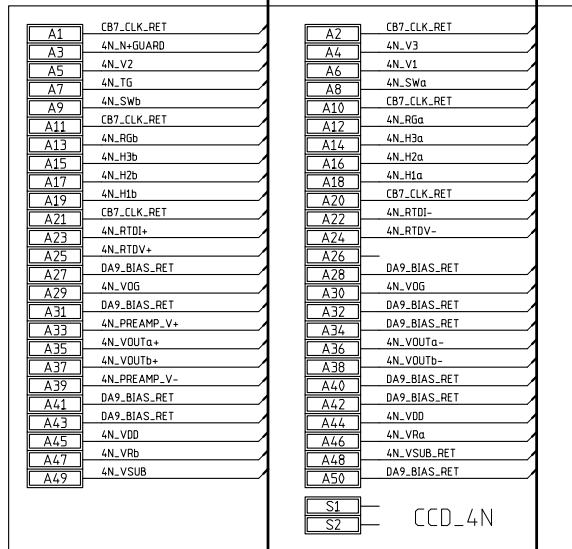

CCD 4N
CB 7 DA 9

AMP 104550-6
EEDP149
EEDP148

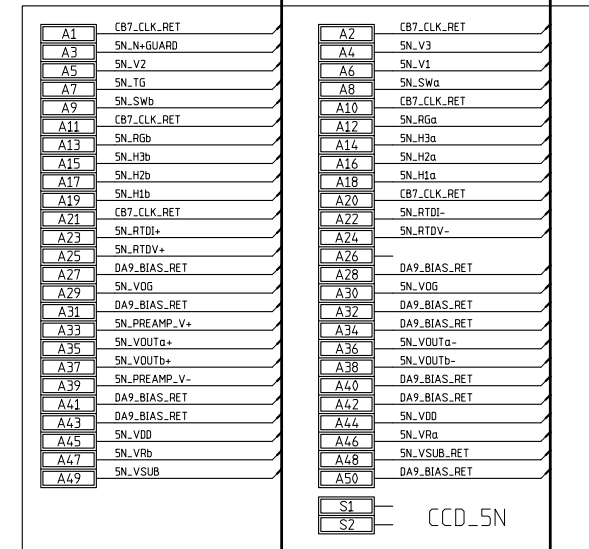

CCD 5N
CB 7 DA 9

AMP 104550-6
EEDP147
EEDP146

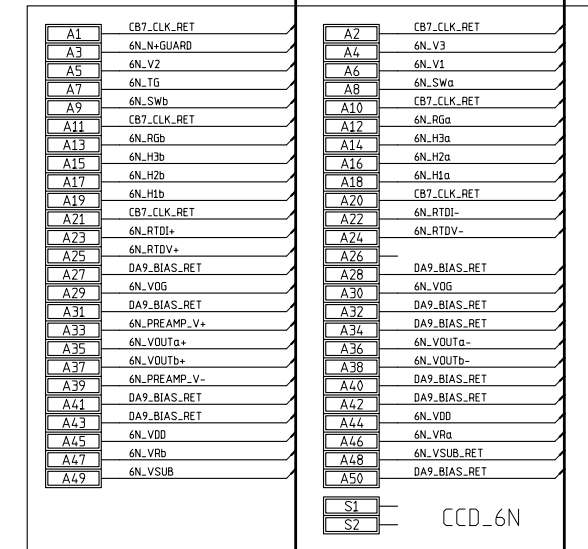

CCD 6N
CB 7 DA 9

AMP 104550-6
EEDP145
EEDP144

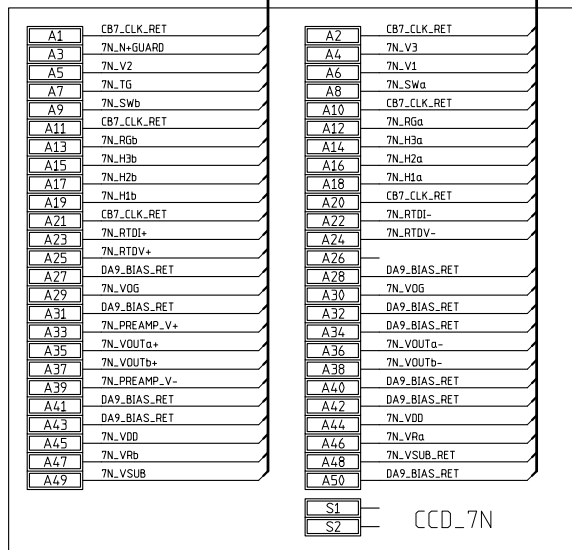

CCD 7N
CB 7 DA 9

AMP 104550-6
EEDP139
EEDP138

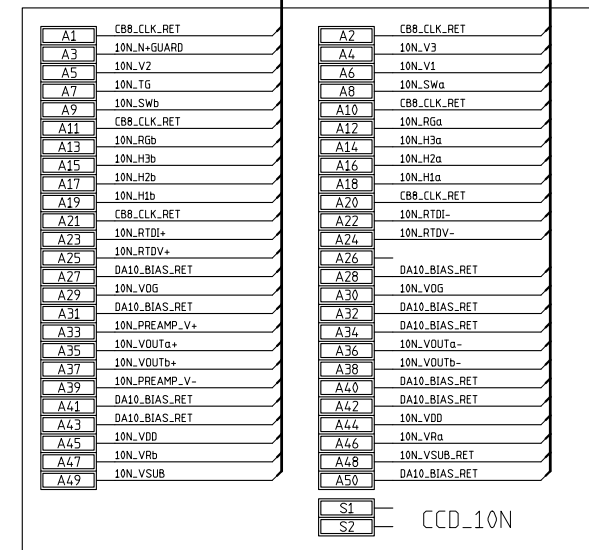

CCD 10N
CB 8 DA 10

AMP 104550-6
EEDP141
EEDP140

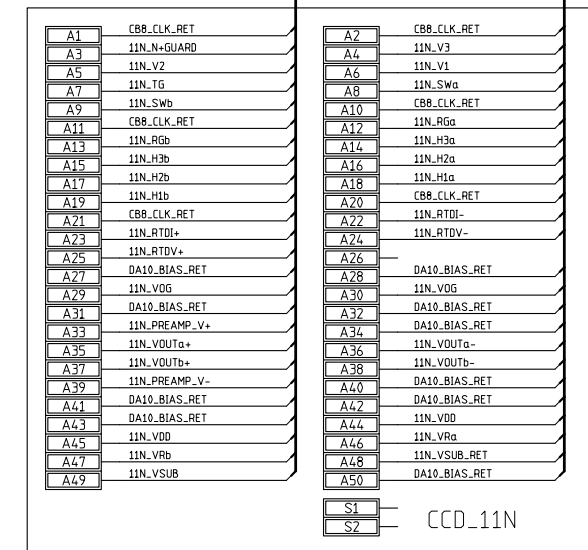

CCD 11N
CB 8 DA 10

AMP 104550-6
EEDP143
EEDP142

VIB-INTERFACE CARDS

MODIFIED 2/24/2010 11:23:02 AM			
EED Department	ORIGINATOR	Walter Stuermer	DATE 10/26/2009
	DRAWN	drawn	DATE date
	CHECKED	checked	DATE date
	APPROVED	approved	DATE date
Fermi National Accelerator Laboratory United States Department of Energy			
U:\CAD Projects\DES Cad Projects\PPD_JOBS\DES_FP5_VIB.B\DES_FP5_VIB_B.prj			
SIZE	DRAWING NUMBER	Schematic Page 22 of 27	REV
D	173694		A

VIB-WEST 2.0

Dark Energy Survey

ALL_SIGNALS

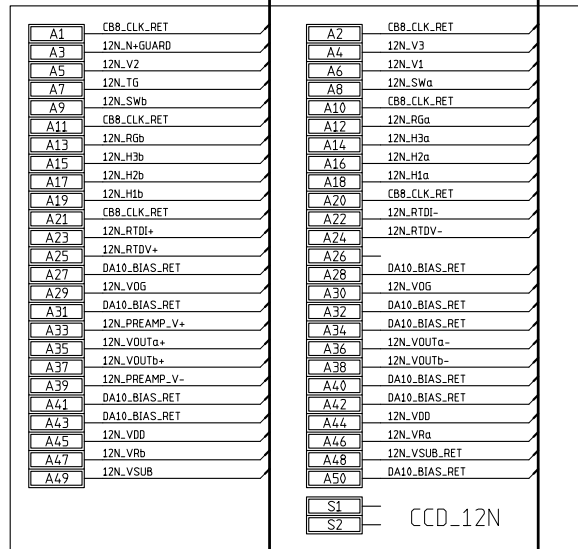

CCD 12N
CB 8 DA 10

AMP 104550-6
EEDP117

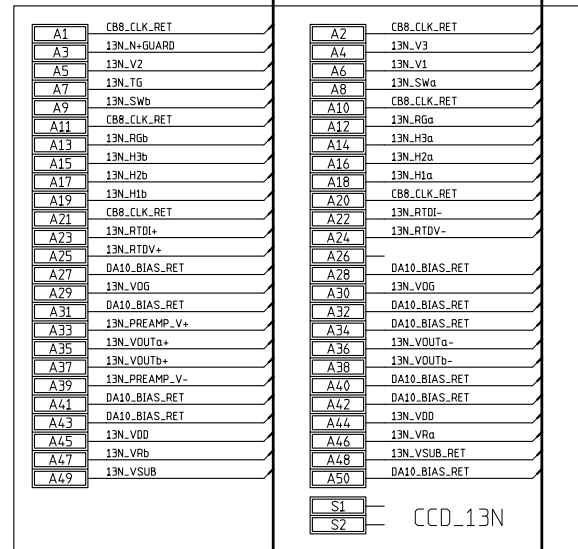

CCD 13N
CB 8 DA 10

AMP 104550-6
EEDP115

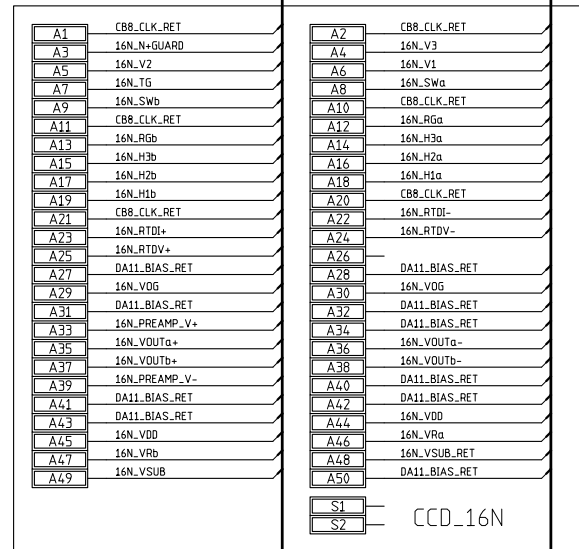

CCD 16N
CB 8 DA 11

AMP 104550-6
EEDP114

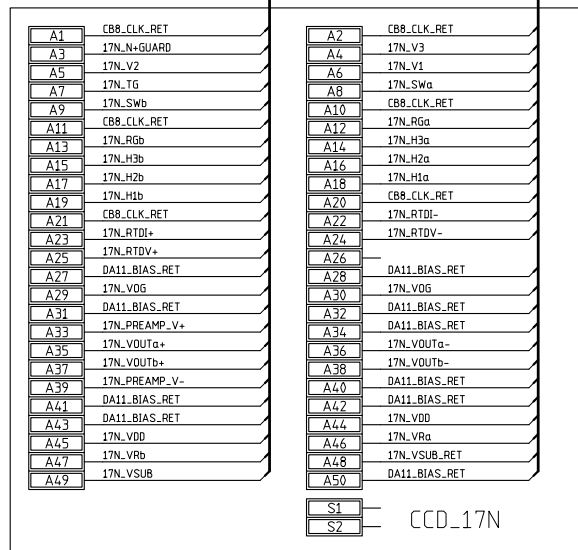

CCD 17N
CB 8 DA 11

AMP 104550-6
EEDP117

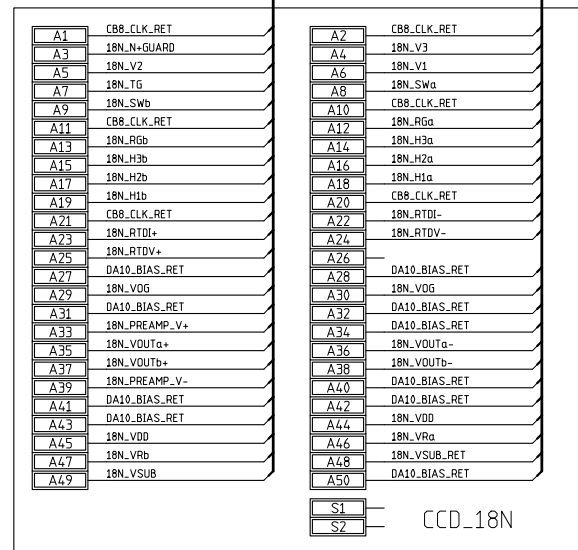

CCD 18N
CB 8 DA 10

AMP 104550-6
EEDP115

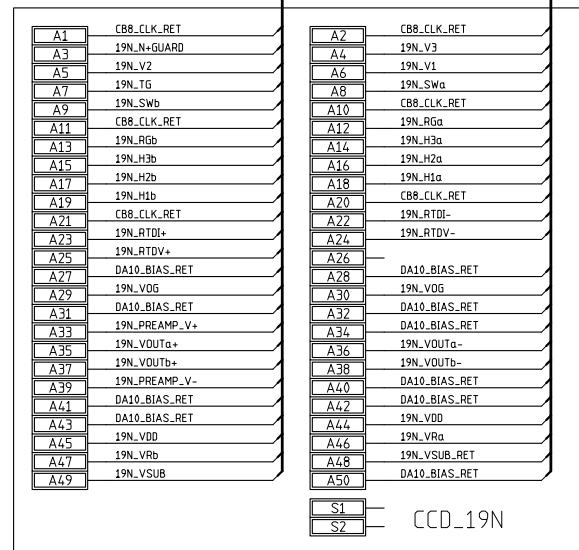

CCD 19N
CB 8 DA 10

AMP 104550-6
EEDP115

VIB-INTERFACE CARDS

MODIFIED 2/24/2010 11:23:02 AM			
EED Department	ORIGINATOR	Walter Stuermer	DATE 10/26/2009
	DRAWN	drawn	DATE date
	CHECKED	checked	DATE date
	APPROVED	approved	DATE date
 Fermi National Accelerator Laboratory United States Department of Energy			
U:\CAD Projects\DES Cad Projects\PPP5_JOBS6\DES_FP5_VIB.B\DES_FP5_VIB_B.pj			
SIZE	DRAWING NUMBER	Schematic Page 23 of 27	REV
D	173694		A

VIB-WEST 2.0

Dark Energy Survey

ALL SIGNALS

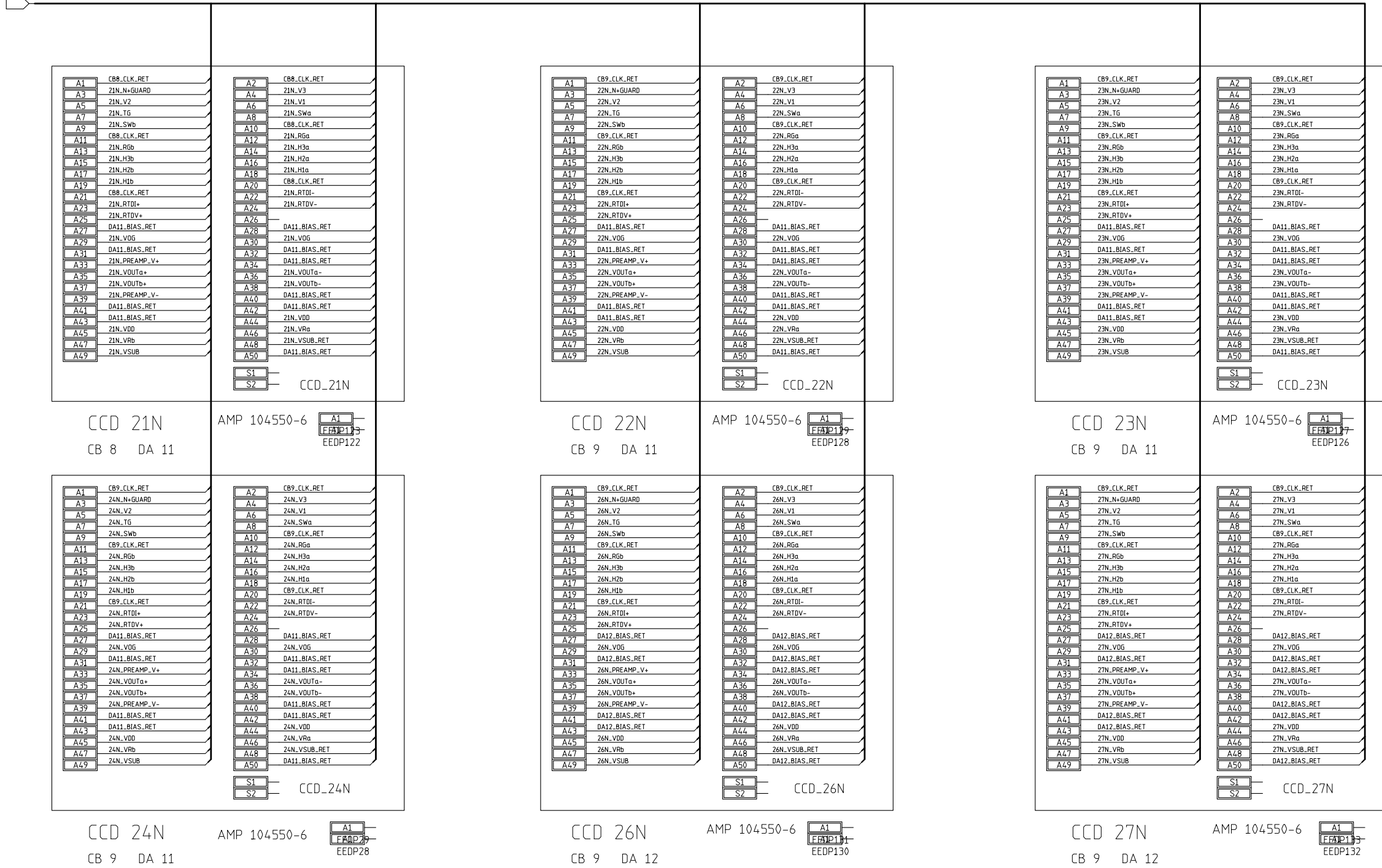

VIB-INTERFACE CARDS

MODIFIED 2/24/2010 11:23:02 AM			
EED Department	ORIGINATOR	Walter Stuermer	DATE 10/26/2009
	DRAWN	drawn	DATE date
	CHECKED	checked	DATE date
	APPROVED	approved	DATE date
 Fermi National Accelerator Laboratory United States Department of Energy			
U:\CAD Projects\DES Cad Projects\PPP05\DES_FP5_VIB.B\DES_FP5_VIB_B.pj			
SIZE	DRAWING NUMBER	Schematic Page 24 of 27	REV
D	173694		A

VIB-WEST 2.0

Dark Energy Survey

ALL_SIGNALS

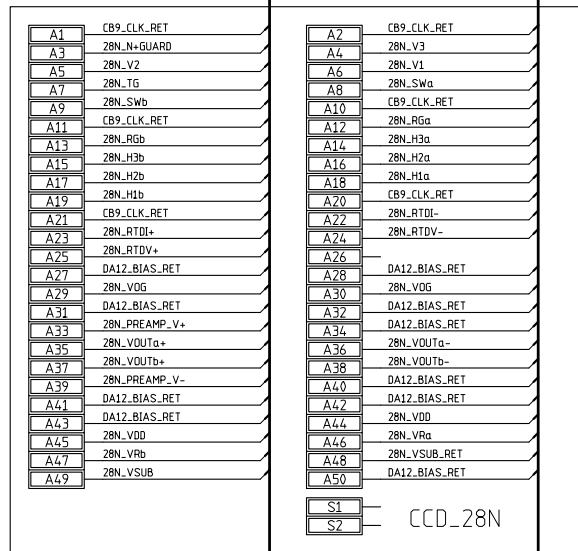

CCD 28N
CB 9 DA 12
AMP 104550-6
EEDP26

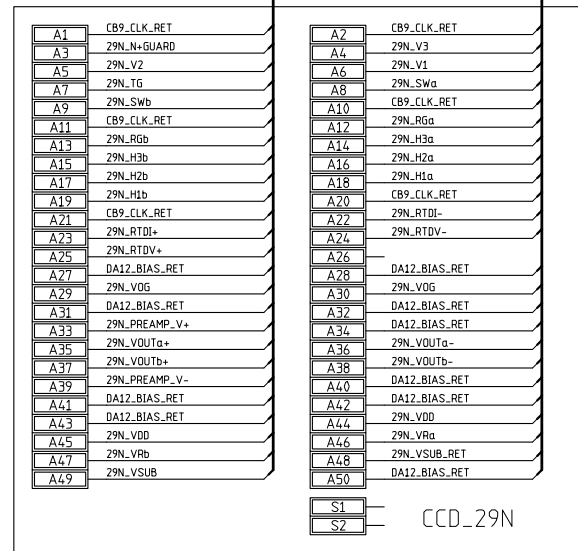

CCD 29N
CB 9 DA 12
AMP 104550-6
EEDP24

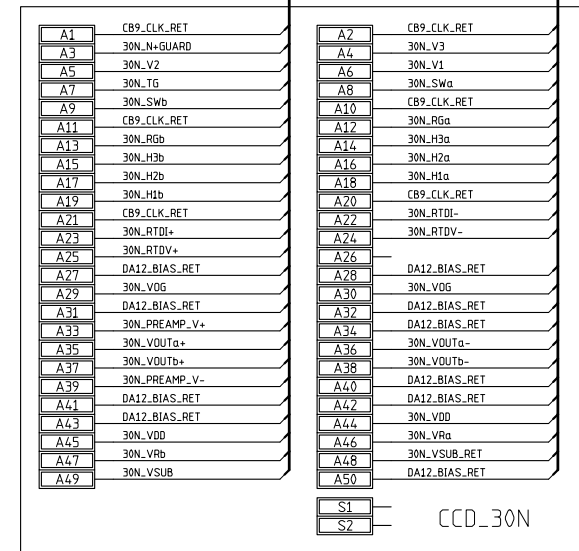

CCD 30N
CB 9 DA 12
AMP 104550-6
EEDP22

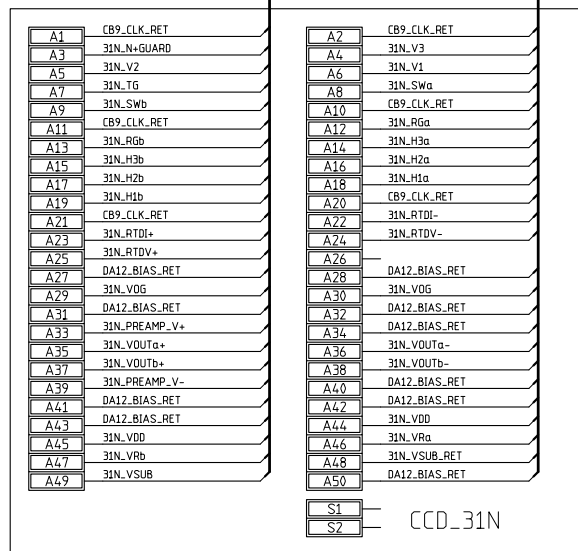

CCD 31N
CB 9 DA 12
AMP 104550-6
EEDP20

VIB-INTERFACE CARDS

MODIFIED 2/24/2010 11:23:02 AM			
EED Department	ORIGINATOR	Walter Stuermer	DATE 10/26/2009
	DRAWN	drawn	DATE date
	CHECKED	checked	DATE date
	APPROVED	approved	DATE date
Fermi National Accelerator Laboratory United States Department of Energy			
U:\CAD Projects\DES Cad Projects\PPD_JOBS6\DES_FP5_VIB.B\DES_FP5_VIB_B.pj			
SIZE	DRAWING NUMBER	Schematic Page 25 of 27	REV
D	173694		A

VIB-WEST 2.0

Dark Energy Survey

ALL_SIGNALS

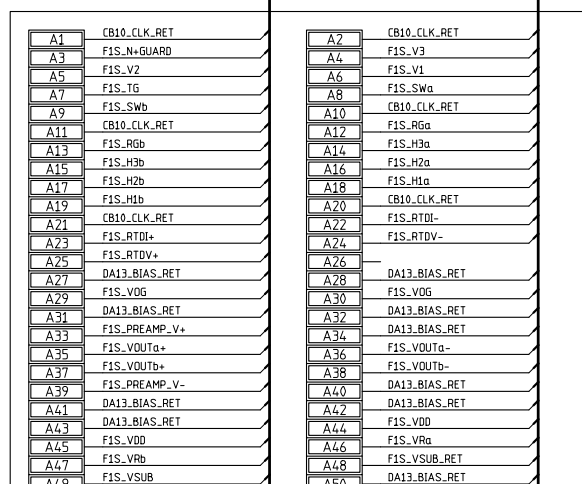

CCD F1S
CB 10 DA 13

AMP 104550-6
EEDP7
EEDP19

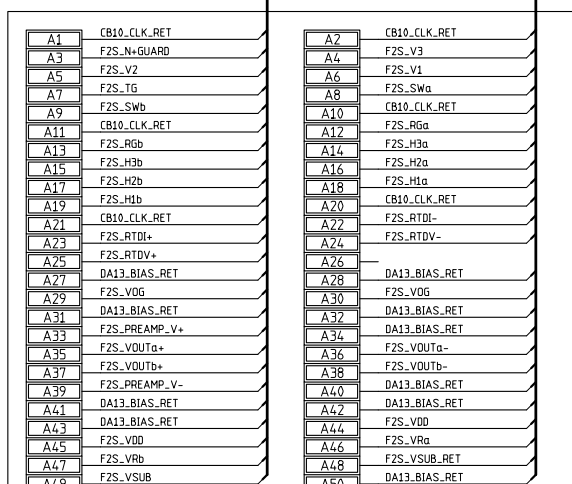

CCD F2S
CB 10 DA 13

AMP 104550-6
EEDP9
EEDP10

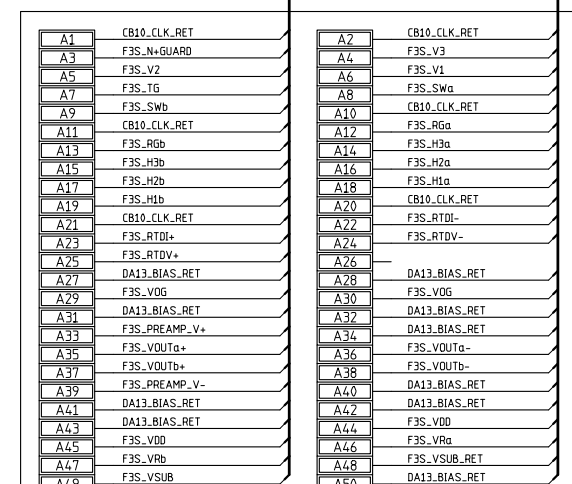

CCD F3S
CB 10 DA 13

AMP 104550-6
EEDP11
EEDP12

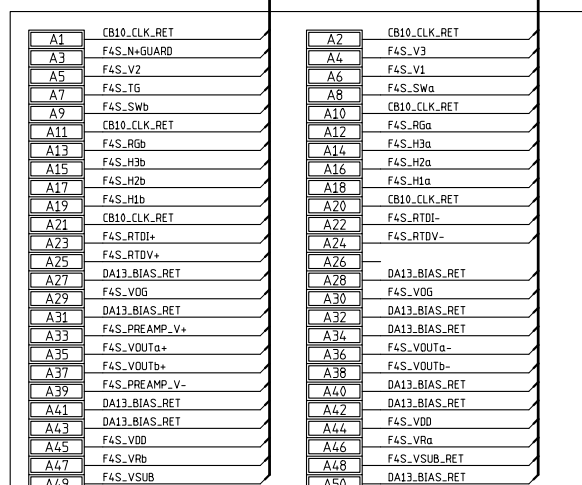

CCD F4S
CB 10 DA 13

AMP 104550-6

VIB-INTERFACE CARDS

MODIFIED 2/24/2010 11:23:02 AM			
EED Department	ORIGINATOR	Walter Stuermer	DATE 10/26/2009
	DRAWN	drawn	DATE date
	CHECKED	checked	DATE date
	APPROVED	approved	DATE date
 Fermi National Accelerator Laboratory United States Department of Energy			
U:\CAD Projects\DES Cad Projects\PPD_JOBS6\DES_FP5_VIB.B\DES_FP5_VIB_B.prj			
SIZE	DRAWING NUMBER	Schematic Page 34 of 27	REV
D	173694		A

VIB-WEST 2.0

Dark Energy Survey

ALL_SIGNALS

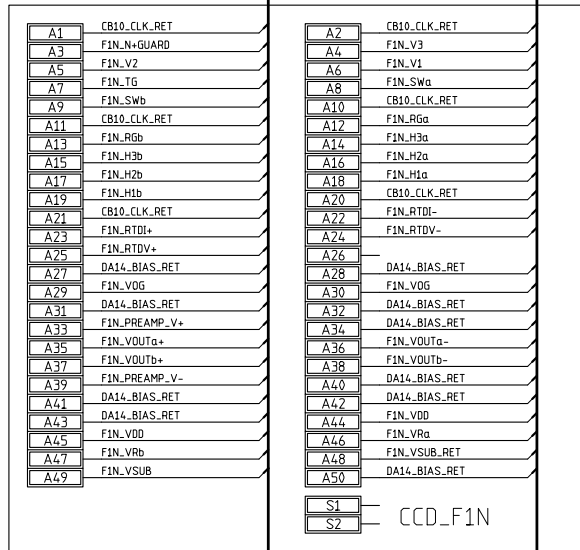

CCD F1N
CB 10 DA 14

AMP 104550-6

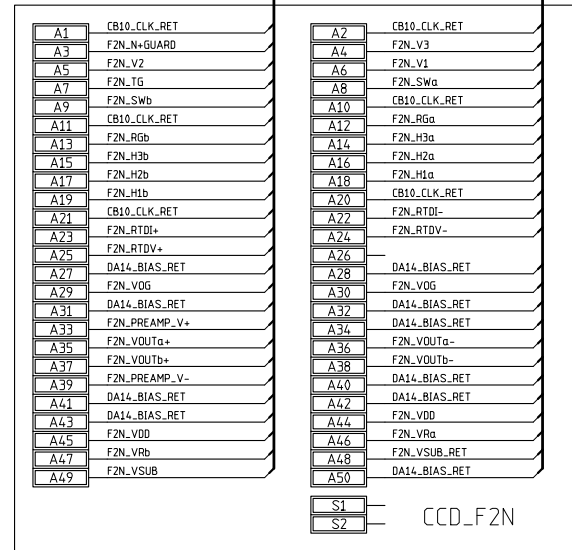

CCD F2N
CB 10 DA 14

AMP 104550-6

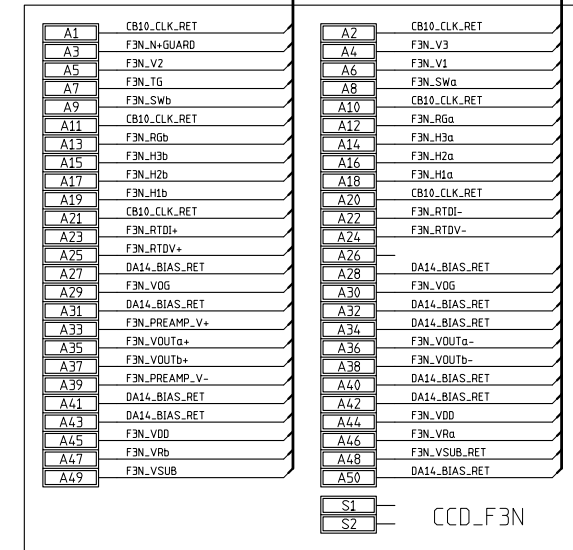

CCD F3N
CB 10 DA 14

AMP 104550-6

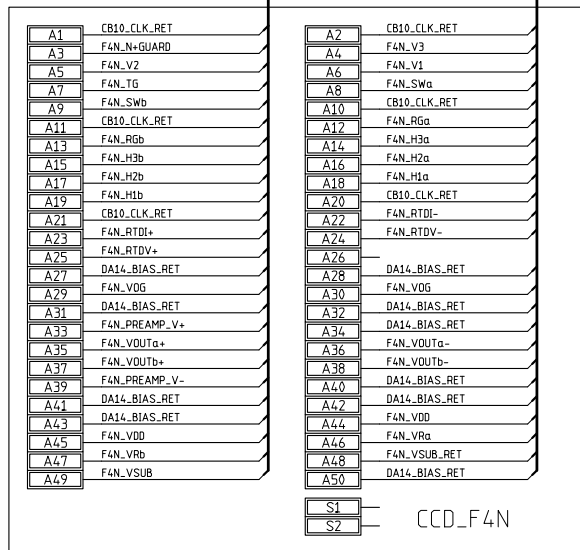

CCD F4N
CB 10 DA 14

AMP 104550-6

A1
EEDP37

VIB-INTERFACE CARDS

MODIFIED 2/24/2010 11:23:02 AM			
EED Department	ORIGINATOR	Walter Stuermer	DATE 10/26/2009
	DRAWN	drawn	DATE date
	CHECKED	checked	DATE date
	APPROVED	approved	DATE date
 Fermi National Accelerator Laboratory United States Department of Energy			
U:\CAD Projects\DES Cad Projects\PPP06\DES_FP5_VIB.B\DES_FP5_VIB_B.ppt			
SIZE D	DRAWING NUMBER 173694	Schematic Page 35 of 27	REV A

VIB-WEST 2.0

Dark Energy Survey

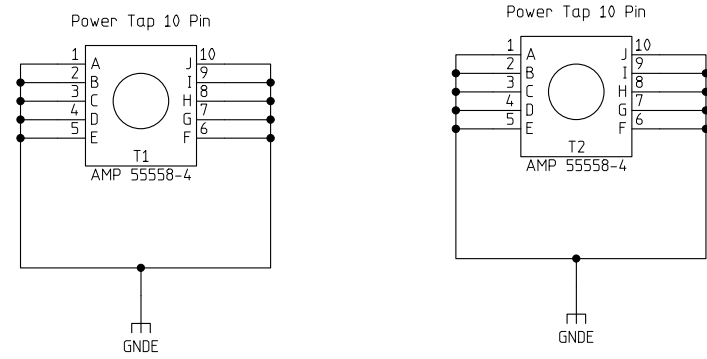

GROUND STRAPS

MODIFIED 2/24/2010 11:41:35 AM			
EED Department	ORIGINATOR	Walter Stuermer	DATE 10/26/2009
	DRAWN	drawn	DATE date
	CHECKED	checked	DATE date
	APPROVED	approved	DATE date
 Fermi National Accelerator Laboratory United States Department of Energy			
U:\CAD Projects\DES Cad Projects\PPP0_JOBS6\DES_FP5_VIB.B\DES_FP5_VIB.B.prj			
SIZE	DRAWING NUMBER	Schematic Page 36 of 27	REV
D	173694		A